

**LECTURE NOTES ON MECHATRONICS**

**MECHANICAL BRANCH**

**5<sup>TH</sup> SEM DIPLOMA**

**AUROBINDO PANDA**

**ASST PROFESSOR**

**MECHANICAL BRANCH**

**GIACR RAYAGADA**

## Module-I

### What is “Mechatronics”?

Mechatronics is a concept of Japanese origin (1980’s) and can be defined as the application of electronics and computer technology to control the motions of mechanical systems.



Definition of Mechatronics

It is a multidisciplinary approach to product and manufacturing system design (Figure). It involves application of electrical, mechanical, control and computer engineering to develop products, processes and systems with greater flexibility, ease in redesign and ability of reprogramming. It concurrently includes all these disciplines.

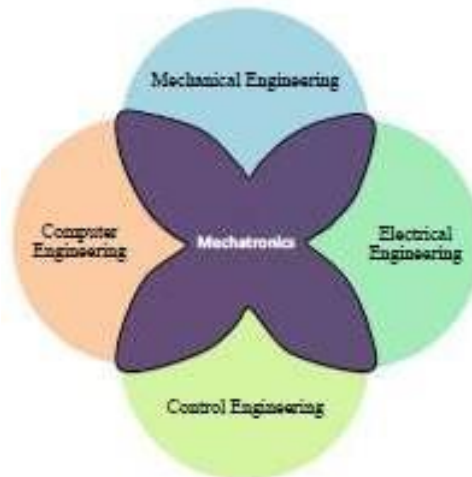

**Mechatronics:** a multi-disciplinary approach

Mechatronics can also be termed as replacement of mechanics with electronics or enhance mechanics with electronics. For example, in modern automobiles, mechanical fuel injection systems are now replaced with electronic fuel injection systems. This replacement made the automobiles more efficient and less pollutant. With the help of microelectronics and sensor technology, mechatronics systems are providing high levels of precision and reliability. It is now possible to move (in x – y plane) the work

table of a modern production machine tool in a step of 0.0001 mm. By employment of reprogrammable microcontrollers/microcomputers, it is now easy to add new functions and capabilities to a product or a system. Today’s domestic washing machines are “intelligent” and four-wheel passenger automobiles are equipped with safety installations such as air-bags, parking (proximity) sensors, antitheft electronic keys etc.

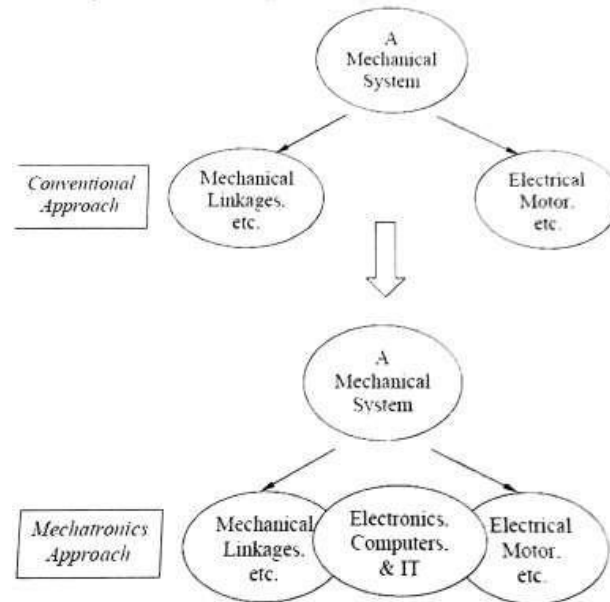

Figure 2 Conventional and mechatronics design approaches.

Convectional design	Mechatronics Design
Bulky componentized systems	Compact integrated systems
Complex mechanism; Complex mechanical mechanisms	Simple Mechanism; Replacement of many complex mechanical components and/or systems with electronic, computer and/or software systems
Cable problem	Bus or wireless communication
Simple control	Integration by information processing (software)
<ul style="list-style-type: none"> <li>• Stiff construction</li> <li>• Feedback control, linear (analog) control</li> <li>• Precision through narrow tolerance</li> <li>• Non measurable quantities changes arbitrarily</li> <li>• Simple monitoring</li> <li>• Fixed abilities</li> </ul>	<ul style="list-style-type: none"> <li>• elastic construction with damping by electronic feedback</li> <li>• programmable feedback, (nonlinear) digital control</li> <li>• precision through measurement and feedback control</li> <li>• control of non-measurable estimated quantities</li> <li>• supervision over fault diagnosis</li> <li>• learning ability</li> </ul>
Centralized processing & control	Hybrid Control: Adaptive and/or Multi-architecture control (e.g., Centralized, Centralized processing & control Decentralized and Distributed)
Constant speed drives	Variable speed drives
Mechanical Systems	Mechanical, Computer, Electronic, Software, and/or Network interface and/or control of physical, chemical, biological and/or neurological systems

**APPLICATIONS**

Today, mechatronic systems are commonly found in homes, offices, schools, shops, and of course, in industrial applications. Common mechatronic systems include:

**Table 2: Applications with product categorization**

Product Categorizations	Product Categorizations Examples
Electronic products	Cameras and audio equipment
Consumer Appliances	Refrigerators and Washing machines
Vehicle systems	Automobiles, Aircraft and Trucks
Communication systems	Satellites, Radar equipment and Telephone switches
Onboard control systems	Aerospace, Marine, Weapons and Space systems
Biomedical instrumentation	MRI, CT scan, and Airport security systems
Office equipment	Computers, Printers, copiers, Fax machines
Industrial machinery and equipment	Turbines, Printing presses, Weapon systems
Large scale transportation equipment	Large aircrafts, Locomotives, Mass transit systems

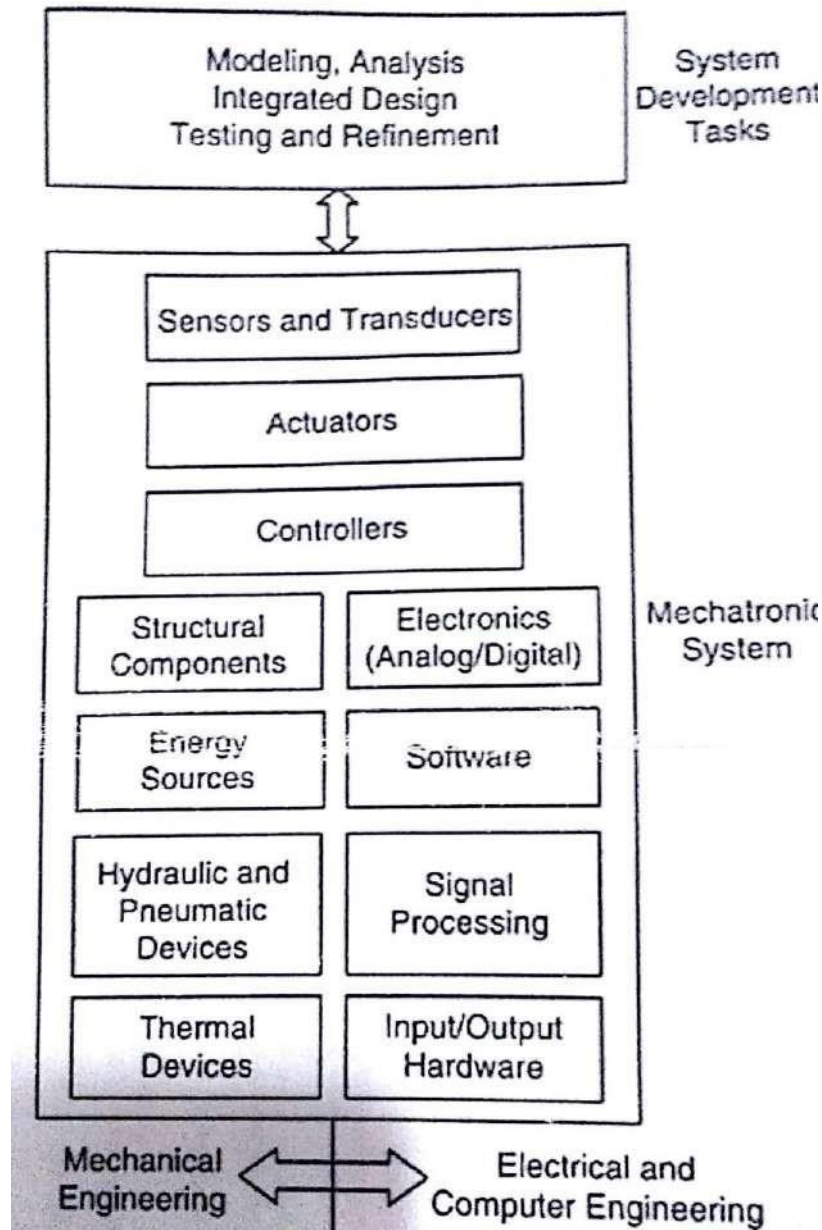

**Concept of Mechatronics System**

### Evolution Level of Mechatronics

1. **Primary Level Mechatronics:** This level incorporates I/O devices such as sensors and actuators that integrates electrical signals with mechanical action at the basic control levels.  
Examples: Electrically controlled fluid valves and relays
2. **Secondary Level Mechatronics:** This level integrates microelectronics into electrically controlled devices.  
Examples: Cassette players
3. **Third Level Mechatronics:** This level incorporates advanced feedback functions into control strategy thereby enhancing the quality in terms of sophistication called smart system.
  - The control strategy includes microelectronics, microprocessor and other 'Application Specific Integrated Circuits' (ASIC)  
Example: Control of Electrical motor used to activate industrial robots, hard disk, CD drives and automatic washing machines.
4. **Fourth Level Mechatronics:** This level incorporates intelligent control in mechatronics system. It introduces intelligence and fault detection and isolation (FDI) capability systems.

### Advantages and Disadvantages of Mechatronics system:

Following are the *advantages* and *disadvantages* of mechatronics :

#### Advantages :

1. The products produced are cost effective and of very good quality.
2. The performance characteristics of mechatronics products are such which are otherwise very difficult to achieve without the synergistic combination.
3. High degree of flexibility.
4. A mechatronics product can be better than just sum of its parts.
5. Greater extent of machine utilisation.
6. Due to the integration of sensors and control systems in a complex system, capital expenses are reduced.
7. Owing to the incorporation of intelligent, self correcting sensory and feedback systems, the *mechatronic approach* results in :
  - greater productivity ;
  - higher quantity and producing reliability.

#### Disadvantages :

1. High initial cost of the system.
2. Imperative to have knowledge of different engineering fields for design and implementation.
3. Specific problems for various systems will have to be addressed separately and properly.
4. It is expensive to incorporate mechatronics approach to an existing/old system.

## Components of Mechatronics system:

The term mechatronics system (sometimes referred to as smart device) encompasses a myriad of devices and systems. Increasingly, microcontrollers are embedded in the electromechanical devices, creating much more flexibility and control possibilities in system design.

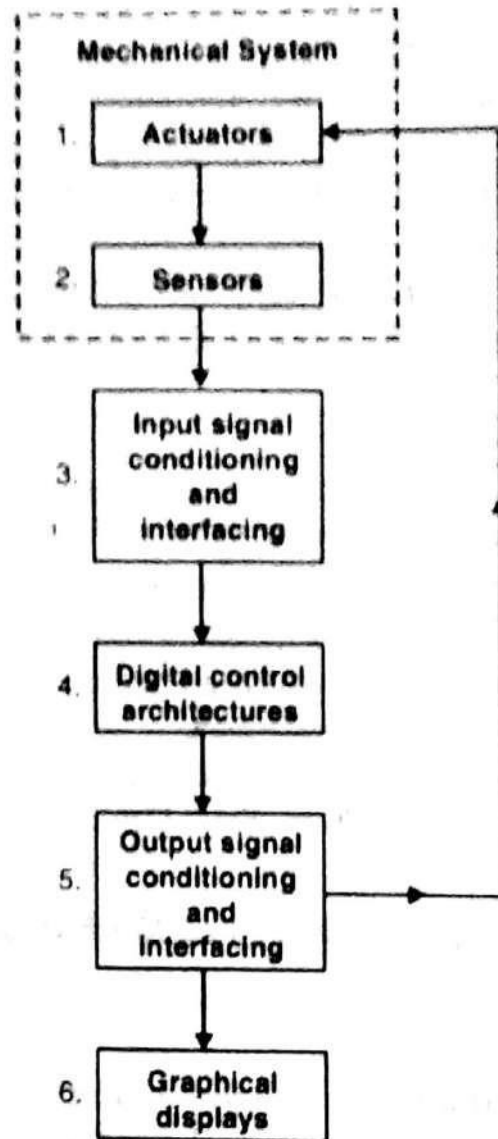

Components of a typical Mechatronics system

- **Actuators:** produce motion or cause some action. Solenoids, voice calls, DC motors, Stepper motor, servomotor, hydraulic, pneumatic.
- **Sensors:** detect the state of the system parameters, inputs and outputs. Switches, potentiometer, photoelctrics, digital encoder, strain gauge, thermocouple, accelerometer etc.

- **Input/output Signal conditioning and interfacing:** provide connection between the control system circuits and the input/output devices. Discrete circuits, amplifiers, filters, A/D, D/A, power transistor etc.
- **Digital devices:** controls the system. Logic circuits, micro controller, SBC, PLC etc
- **Graphic Display:** provide visual feed back to users. LEDs, Digital Displays, LCD, CRT

### Importance of Mechatronics in automation:

#### Design process

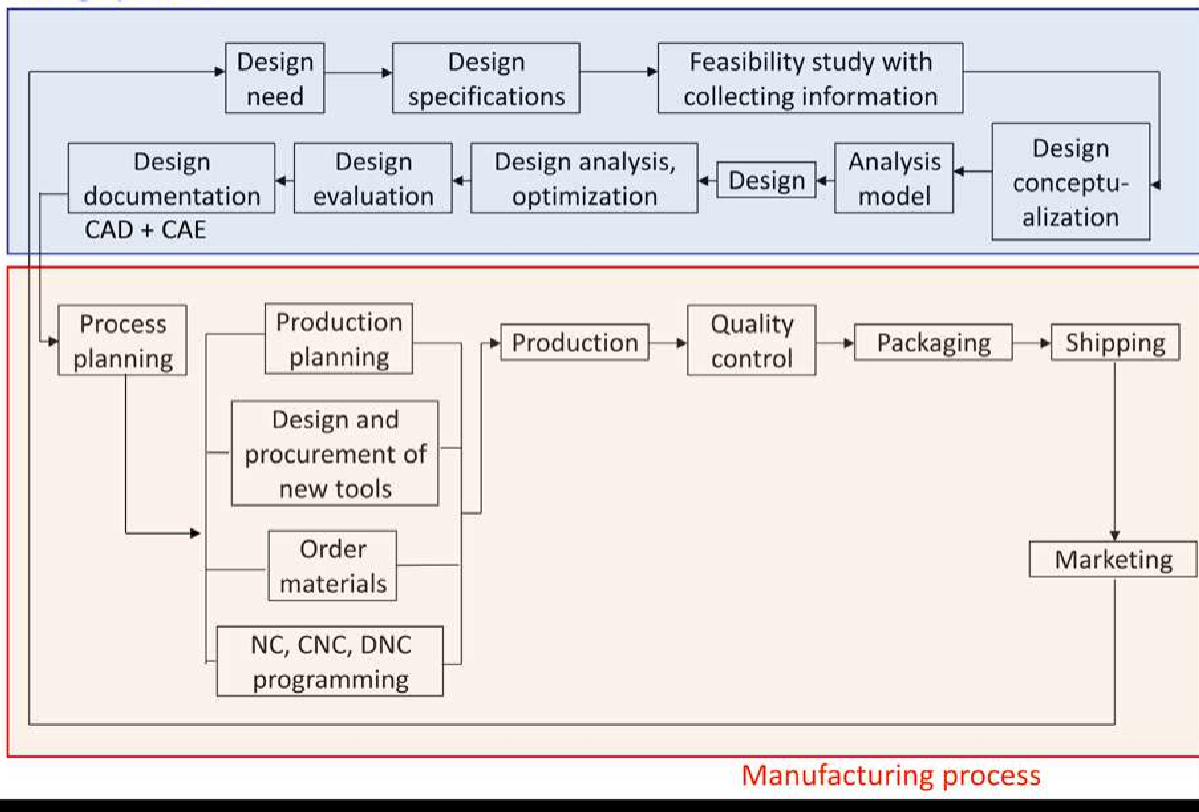

#### Operations involved in design and manufacturing of a product

Today's customers are demanding more variety and higher levels of flexibility in the products. Due to these demands and competition in the market, manufacturers are thriving to launch new/modified products to survive. It is reducing the product life as well as lead-time to manufacture a product. It is therefore essential to automate the manufacturing and assembly operations of a product. There are various activities involved in the product manufacturing process. These are shown in figure 1.1.3. These activities can be classified into two groups viz. design and manufacturing activities.

Mechatronics concurrently employs the disciplines of mechanical, electrical, control and computer engineering at the stage of design itself. Mechanical discipline is employed in terms of various machines and mechanisms, where as electrical engineering as various electric prime movers viz. AC/DC, servo motors and other systems is used. Control engineering helps in the development of various electronics-based control systems to enhance or replace the mechanics of the mechanical systems. Computers are widely used to write various softwares to control the control systems; product design and development activities; materials and manufacturing resource planning, record keeping, market survey, and other sales related activities.

Using computer aided design (CAD) / computer aided analysis (CAE) tools, three-dimensional models of products can easily be developed. These models can then be analyzed and can be simulated to study their performances using numerical tools. These numerical tools are being continuously updated or enriched with the real-life performances of the similar kind of products. These exercises provide an approximate idea about performance of the product/system to the design team at the early stage of the product development. Based on the simulation studies, the designs can be modified to achieve better performances. During the conventional design-manufacturing process, the design assessment is generally carried out after the production of first lot of the products. This consumes a lot of time, which leads to longer (in months/years) product development lead-time. Use of CAD-CAE tools saves significant time in comparison with that required in the conventional sequential design process.

CAD-CAE generated final designs are then sent to the production and process planning section. Mechatronics based systems such as computer aided manufacturing (CAM): automatic process planning, automatic part programming, manufacturing resource planning, etc. uses the design data provided by the design team. Based these inputs, various activities will then be planned to achieve the manufacturing targets in terms of quality and quantity with in a stipulated time frame.

Mechatronics based automated systems such as automatic inspection and quality assurance, automatic packaging, record making, and automatic dispatch help to expedite the entire manufacturing operation. These systems certainly ensure a supply better quality, well packed and reliable products in the market. Automation in the machine tools has reduced the human



intervention in the machining operation and improved the process efficiency and product quality. Therefore, it is important to study the principles of mechatronics and to learn how to apply them in the automation of a manufacturing system.

## Digital Codes:

In digital circuits, each number or piece of information is defined by an equivalent combination of binary digits. A complete group of these combinations which represent numbers, letters or symbols is called a **digital code**.

The group of 0s and 1s in the binary number can be thought of as a code representing the decimal numbers. When a decimal number is represented by its equivalent binary number, it is called a *straight binary coding*.

In modern digital equipment, codes are used to represent and process numerical information.

**Types of codes.** The various types of codes are enumerated and briefly discussed below :

### 1. BCD Code

It is also known as 'natural BCD' and is very convenient for representing decimal digits in digital circuits.

- It consists of four bits from 0000 to 1001 representing the decimal numbers from 0 to 9. 1010 to 1111 are don't care conditions since they do not have any meaning in BCD.

### 2. Excess-3 Code

- The code can be derived from BCD by *adding 3 to each coded number*.

It is useful when it is desired to obtain the 9's complement of a decimal digit represented by this code. The 9's complement is obtained simply by complementing each bit.

- This code can be *conveniently used for performing subtracting operations in digital computers*.

### 3. Gray Code

- In this code only one bit changes between any two successive numbers.
- It is mainly *used in the location of angular positions of a rotating shaft*.

### 4. Octal Code

- The octal system is a 8 base system.
- It uses 3 bits to represent one octal digit.

### 5. Hexadecimal Code

- The hexadecimal system is a base 16 system.
- It uses four bits to represent one hexadecimal digit.
- The hexadecimal digits are represented as 0 to 9 continued by alphabetical characters from A to F.

---

## Logic Gates:

**General aspects :**

A digital circuit with one or more input signals but only output signal is called a logic gate.

A logic gate is an electronic circuit which makes logic decision.

- Logic gates are the basic building blocks from which most of the digital systems are built up. They implement the hardware logic function based on the logical algebra developed by George Boolean which is called *Boolean algebra* in his honour.
  - A unique characteristic of Boolean algebra is that variables used in it can assume only one of the two values i.e., either 0 or 1. Hence, every variable is either a 0 or a 1 (Fig. 2.106—limits on TTLIC's).
- Each gate has distinct graphic symbol and its operation can be described by means of Boolean algebraic function.

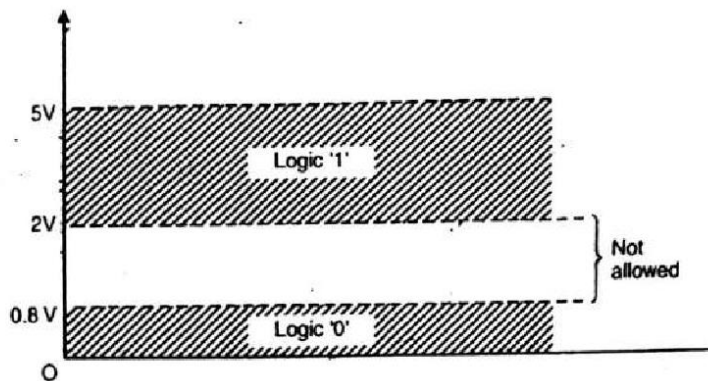

**Fig. 2.106.** Voltage assignment in a digital system.

- The table which indicates output of gate for all possible combinations of input is known as a *truth table*.
- These gates are available today in the form of various IC families. The most popular families are :
  - (i) Transistor-transistor logic (TTL)
  - (ii) Emitter-coupled logic (ECL)
  - (iii) Metal-oxide-semiconductor (MOS)
  - (iv) Complementary metal-oxide-semiconductor (CMOS).

**Applications of logic gates :**

The following are the *fields of application of logic gates* :

1. Calculators and computers.
2. Digital measuring techniques.
3. Digital processing of communications.
4. Musical instruments.
5. Games and domestic appliances, etc.
6. The logic gates are also employed for decision making in automatic control of machines and various industrial processes and for building more complex devices such as binary counters etc.

**Positive and negative logic :**

The number symbols 0 and 1 represent, in computing systems, two possible states of a circuit or device. It does not make any difference if these two states are referred to as

## A Textbook of Mechatronics

'ON' and 'OFF', 'Closed' and 'Open', 'High' and 'Low', 'Plus' and 'Minus' or 'True' and 'False' depending upon the situations. The main point is they must be symbolized by two opposite conditions. In positive logic a '1' represents: an 'ON circuit'; a 'Closed switch'; a 'High voltage', a 'Plus sign', 'True statement'. Consequently, a 0 represent: an 'OFF circuit'; an 'Open switch', a 'Low voltage'; a 'Minus sign', a 'False statement'.

In negative logic, the just opposite conditions prevail.

**Example.** A digital system has two voltage levels of 0 V and 5 V. If we say that symbol 1 stands for 5 V and symbol 0 for 0 V, then we have *positive logic system*. If on the other hand, we decide that a 1 should represent 0 V and 0 should represent 5 V, then we will get negative logic system.

Main point is that in '*positive logic*' the *more positive* of the two voltage levels represents the 1 while in '*negative logic*' the *more negative* voltage represents the 1.

**Types of Logic Gates :** Refer to table 2.4 (page 126)

In the *complex circuits*, the following six different digital electronics gates are used as basic elements :

1. NOT Gate
2. NAND Gate
3. AND Gate
4. OR Gate
5. NOR Gate
6. XOR Gate.

— A truth table has  $2^n$  rows. It gives in each of its row  $m$  outputs for a given combination of  $n$  inputs.

1. NOT Gate :

- Not operation means that the output is the complement of input. If input is logic '1', the output is logic '0' and if input is logic '0', the output is logic '1'.
- Fig. 2.107 shows the symbol of NOT Gate. It is generally represented by a triangle followed by a bubble (or a bubble followed by a triangle).
- NOT gate is used when an output is desired to be complement of the input.
- If all inputs of NAND gates are joined it shall act as NOT gate.
- NOT gate is also called '*inverting logic circuit*'. It is also called a '*complementing circuit*'.

2. NAND Gate :

- A NAND gate can said to be *basic building block* of the all digital TTL logic gates and other digital circuits.
- It is represented by the symbol shown in Fig. 2.108.
- Its *unique property* is that output is high '1' if any of the input is at low '0' logic level.





Let us consider two inputs with the states  $A$  and  $B$  at the NAND gate. The answer (output)  $X = \overline{A \cdot B}$ . Bar denotes a NOT log operation on  $A \cdot B$ . The meaning of  $A \cdot B$ , called AND operation, is given in 3 below.

3. AND Gate :

- A NAND gate followed by a NOT gate gives us AND gate.
- It is represented by a symbol in Fig. 2.109. Its symbol differs from NAND only by omission of a bubble (circle).
- Its *unique property* is that its output is '0' unless all the inputs to it are at the logic 1's.
- A two inputs, AND gate has  $X = A \cdot B$ . Dot between the two states indicates 'AND' logic operation using these.

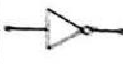
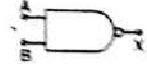
4. OR Gate :

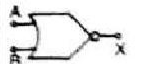
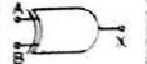
- An 'OR' operation means that the output is '0' only if all the inputs are '0s'.
- It is represented by a symbol shown in Fig. 2.110.

Logic	NOT	NAND	AND	OR	NOR	EX. OR	COLINCIDENCE																																																																																
Symbol																																																																																							
	<b>Fig. 2.107</b>	<b>Fig. 2.108</b>	<b>Fig. 2.109</b>	<b>Fig. 2.110</b>	<b>Fig. 2.111</b>	<b>Fig. 2.112</b>	<b>Fig. 2.113</b>																																																																																
Boolean expression	$X = \bar{A}$	$X = \overline{A \cdot B}$	$X = A \cdot B$	$X = A + B$	$X = \overline{A + B}$	$X = A \cdot \bar{B} + \bar{A} \cdot B = A \oplus B$	$X = \bar{A} \cdot \bar{B} + A \cdot B$																																																																																
Truth table	<table border="1"> <tr><td>A</td><td>X</td></tr> <tr><td>0</td><td>1</td></tr> <tr><td>1</td><td>0</td></tr> </table>	A	X	0	1	1	0	<table border="1"> <tr><td>A</td><td>B</td><td>X</td></tr> <tr><td>0</td><td>0</td><td>1</td></tr> <tr><td>0</td><td>1</td><td>1</td></tr> <tr><td>1</td><td>0</td><td>1</td></tr> <tr><td>1</td><td>1</td><td>0</td></tr> </table>	A	B	X	0	0	1	0	1	1	1	0	1	1	1	0	<table border="1"> <tr><td>A</td><td>B</td><td>X</td></tr> <tr><td>0</td><td>0</td><td>0</td></tr> <tr><td>0</td><td>1</td><td>0</td></tr> <tr><td>1</td><td>0</td><td>0</td></tr> <tr><td>1</td><td>1</td><td>1</td></tr> </table>	A	B	X	0	0	0	0	1	0	1	0	0	1	1	1	<table border="1"> <tr><td>A</td><td>B</td><td>X</td></tr> <tr><td>0</td><td>0</td><td>0</td></tr> <tr><td>0</td><td>1</td><td>1</td></tr> <tr><td>1</td><td>0</td><td>1</td></tr> <tr><td>1</td><td>1</td><td>1</td></tr> </table>	A	B	X	0	0	0	0	1	1	1	0	1	1	1	1	<table border="1"> <tr><td>A</td><td>B</td><td>X</td></tr> <tr><td>0</td><td>0</td><td>1</td></tr> <tr><td>0</td><td>1</td><td>0</td></tr> <tr><td>1</td><td>0</td><td>0</td></tr> <tr><td>1</td><td>1</td><td>0</td></tr> </table>	A	B	X	0	0	1	0	1	0	1	0	0	1	1	0	<table border="1"> <tr><td>A</td><td>B</td><td>X</td></tr> <tr><td>0</td><td>0</td><td>1</td></tr> <tr><td>0</td><td>1</td><td>0</td></tr> <tr><td>1</td><td>0</td><td>0</td></tr> <tr><td>1</td><td>1</td><td>1</td></tr> </table>	A	B	X	0	0	1	0	1	0	1	0	0	1	1	1
A	X																																																																																						
0	1																																																																																						
1	0																																																																																						
A	B	X																																																																																					
0	0	1																																																																																					
0	1	1																																																																																					
1	0	1																																																																																					
1	1	0																																																																																					
A	B	X																																																																																					
0	0	0																																																																																					
0	1	0																																																																																					
1	0	0																																																																																					
1	1	1																																																																																					
A	B	X																																																																																					
0	0	0																																																																																					
0	1	1																																																																																					
1	0	1																																																																																					
1	1	1																																																																																					
A	B	X																																																																																					
0	0	1																																																																																					
0	1	0																																																																																					
1	0	0																																																																																					
1	1	0																																																																																					
A	B	X																																																																																					
0	0	1																																																																																					
0	1	0																																																																																					
1	0	0																																																																																					
1	1	1																																																																																					
Definition	Output available - when there is no input.	Output available - to all states except when all the inputs are available.	Output available - when all inputs available.	Output available - when only one or more inputs available.	Output available - when no input is available.	Output available - when the inputs are not identical.	Output available - to those states when the inputs are identical.																																																																																

## **Module-II**

Sensors and Transducers: An introduction to sensors and Transducers, use of sensor and transducer for specific purpose in mechatronics. Transducer signal conditioning and Devices for Data conversion programmable controllers. ;

### **Sensors and transducers**

Measurement is an important subsystem of a mechatronics system. Its main function is to collect the information on system status and to feed it to the micro-processor(s) for controlling the whole system.

Measurement system comprises of sensors, transducers and signal processing devices. Today a wide variety of these elements and devices are available in the market.

For a mechatronics system designer it is quite difficult to choose suitable sensors/transducers for the desired application(s). It is therefore essential to learn the principle of working of commonly used sensors/transducers.

Sensors in manufacturing are basically employed to automatically carry out the production operations as well as process monitoring activities. Sensor technology has the following important advantages in transforming a conventional manufacturing unit into a modern one.

- Sensors alarm the system operators about the failure of any of the sub units of manufacturing system. It helps operators to reduce the downtime of complete manufacturing system by carrying out the preventative measures.
- Reduces requirement of skilled and experienced labors.
- Ultra-precision in product quality can be achieved.

### **Sensor**

It is defined as an element which produces signal relating to the quantity being measured. According to the Instrument Society of America, sensor can be defined as “*A device which provides a usable output in response to a specified measurand.*” Here, the output is usually an ‘electrical quantity’ and measurand is a ‘physical quantity, property or condition which is to be measured’. Thus in the case of, say, a variable inductance displacement

element, the quantity being measured is displacement and the sensor transforms an input of displacement into a change in inductance.

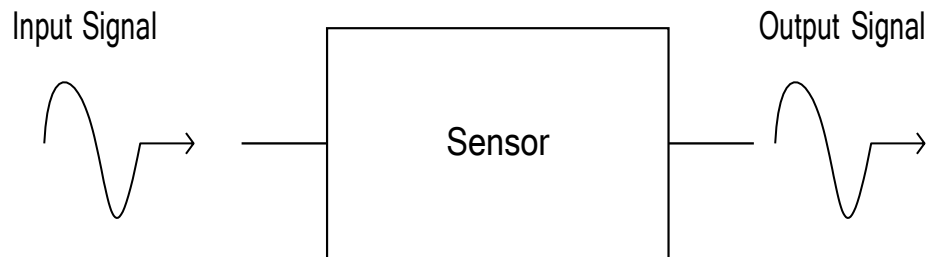

Sensors are also called detectors.

### Need for Sensors

- Sensors are omnipresent. They are embedded in our bodies, automobiles, airplanes, cellular telephones, radios, chemical plants, industrial plants and countless other applications.
- Without the use of sensors, there would be no automation

### Transducer

It is defined as an element when subjected to some physical change experiences a related change or an element which converts a specified measurand into a usable output by using a transduction principle. It can also be defined as a device that converts a signal from one form of energy to another form.

A wire of Constantan alloy (copper-nickel 55-45% alloy) can be called as a sensor because variation in mechanical displacement (tension or compression) can be sensed as change in electric resistance. This wire becomes a transducer with appropriate electrodes and input-output mechanism attached to it. Thus we can say that 'sensors are transducers'.

### Basic elements of transducer

- There are basically two elements which construct a transducer and they are
- A sensing ELEMENT

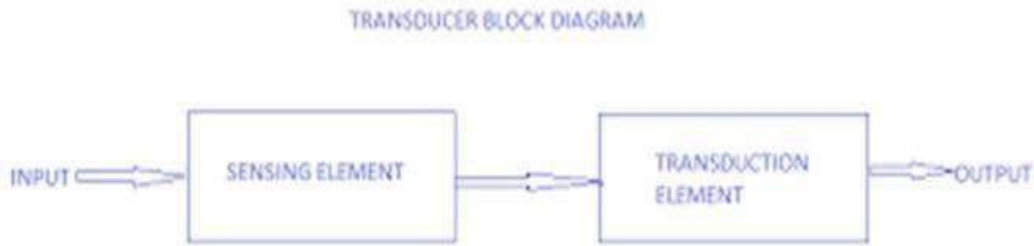

## Sensor/transducers specifications

Transducers or measurement systems are not perfect systems. Mechatronics design engineer must know the capability and shortcoming of a transducer or measurement system to properly assess its performance. There are a number of performance related parameters of a transducer or measurement system. These parameters are called as sensor specifications.

Sensor specifications inform the user to the about deviations from the ideal behavior of the sensors. Following are the various specifications of a sensor/transducer system.

### 1. Range

The range of a sensor indicates the limits between which the input can vary. For example, a thermocouple for the measurement of temperature might have a range of 25-225 °C.

### 2. Span

The span is difference between the maximum and minimum values of the input. Thus, the above-mentioned thermocouple will have a span of 200 °C.

### 3. Error

Error is the difference between the result of the measurement and the true value of the quantity being measured. A sensor might give a displacement reading of 29.8 mm, when the actual displacement had been 30 mm, then the error is -0.2 mm.

### 4. Accuracy

The accuracy defines the closeness of the agreement between the actual measurement result and a true value of the measurand. It is often expressed as a percentage of the full range output or full-scale deflection. A

piezoelectric transducer used to evaluate dynamic pressure phenomena associated with explosions, pulsations, or dynamic pressure conditions in motors, rocket engines, compressors, and other pressurized devices is capable to detect pressures between 0.1 and 10,000 psig (0.7 KPa to 70 MPa). If it is specified with the accuracy of about  $\pm 1\%$  full scale, then the reading given can be expected to be within  $\pm 0.7$  MPa.

### 5. Sensitivity

Sensitivity of a sensor is defined as the ratio of change in output value of a sensor to the per unit change in input value that causes the output change. For example, a general purpose thermocouple may have a sensitivity of  $41 \mu\text{V}/^\circ\text{C}$ .

### 6. Nonlinearity

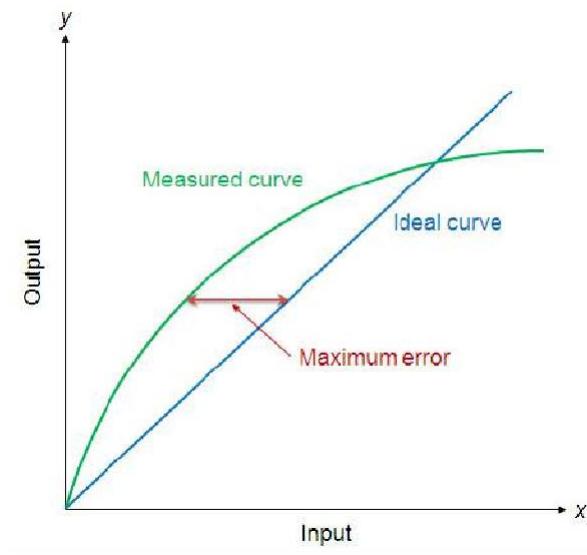

Non-linearity error

The nonlinearity indicates the maximum deviation of the actual measured curve of a sensor from the ideal curve. Figure above shows a somewhat exaggerated relationship between the ideal, or least squares fit, line and the actual measured or *calibration* line. Linearity is often specified in terms of *percentage of nonlinearity*, which is defined as:

Nonlinearity (%) = Maximum deviation in input / Maximum full scale input (1)

The static nonlinearity defined by Equation (1) is dependent upon environmental factors, including temperature, vibration, acoustic noise level,



and humidity. Therefore it is important to know under what conditions the specification is valid.

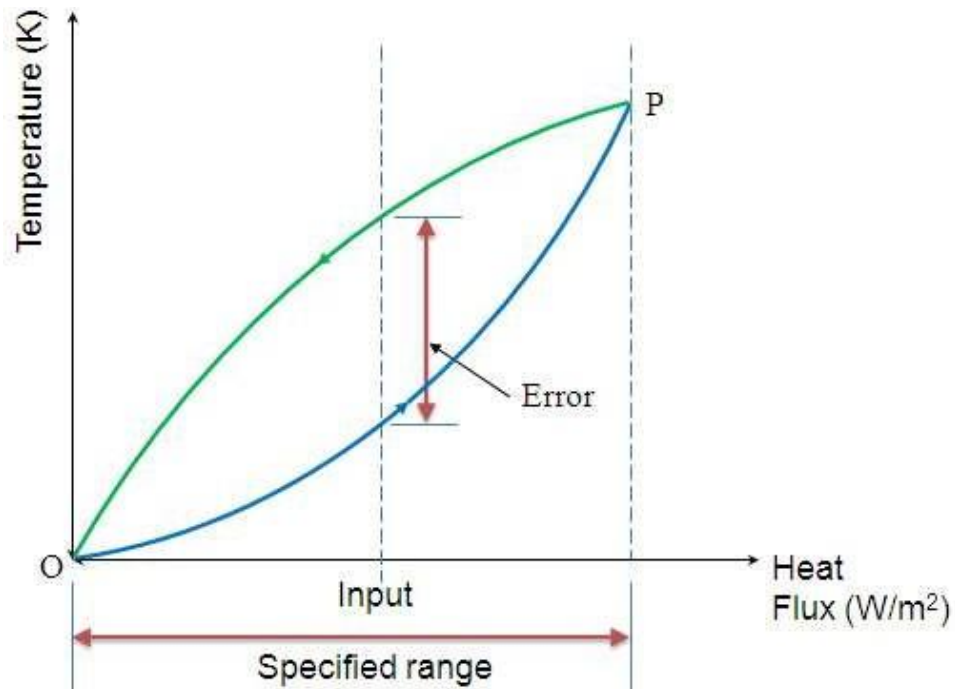

### 7. Hysteresis

#### Hysteresis error curve

The hysteresis is an error of a sensor, which is defined as the maximum difference in output at any measurement value within the sensor's specified range when approaching the point first with increasing and then with decreasing the input parameter. Figure above shows the hysteresis error might have occurred during measurement of temperature using a thermocouple. The hysteresis error value is normally specified as a positive or negative percentage of the specified input range.

### 8. Resolution

Resolution is the smallest detectable incremental change of input parameter that can be detected in the output signal. Resolution can be expressed either as a proportion of the full-scale reading or in absolute terms. For example, if a LVDT sensor measures a displacement up to 20 mm and it provides an output as a number between 1 and 100 then the resolution of the sensor device is 0.2 mm.

### 9. Stability

Stability is the ability of a sensor device to give same output when used to measure a constant input over a period of time. The term 'drift' is used to indicate the change in output that occurs over a period of time. It is expressed as the percentage of full range output.

### **10. Dead band/time**

The dead band or dead space of a transducer is the range of input values for which there is no output. The dead time of a sensor device is the time duration from the application of an input until the output begins to respond or change.

### **11. Repeatability**

It specifies the ability of a sensor to give same output for repeated applications of same input value. It is usually expressed as a percentage of the full range output:

Repeatability = (maximum - minimum values given) X 100 / full range (2)

### **12. Response time**

Response time describes the speed of change in the output on a step-wise change of the measurand. It is always specified with an indication of input step and the output range for which the response time is defined.

## **Classification of sensors**

Sensors can be classified into various groups according to the factors such as measurand, application fields, conversion principle, energy domain of the measurand and thermodynamic considerations. These general classifications of sensors are well described in the references

Detail classification of sensors in view of their applications in manufacturing is as follows.

#### **A. Displacement, position and proximity sensors**

- Potentiometer
- Strain-gauged element
- Capacitive element
- Differential transformers
- Eddy current proximity sensors
- Inductive proximity switch

- Optical encoders
- Pneumatic sensors
- Proximity switches (magnetic)
- Hall effect sensors

#### B. Velocity and motion

- Incremental encoder
- Tachogenerator
- Pyroelectric sensors

#### C. Force

- Strain gauge load cell

#### D. Fluid pressure

- Diaphragm pressure gauge
- Capsules, bellows, pressure tubes
- Piezoelectric sensors
- Tactile sensor

#### E. Liquid flow

- Orifice plate
- Turbine meter

#### F. Liquid level

- Floats
- Differential pressure

#### G. Temperature

- Bimetallic strips
- Resistance temperature detectors
- Thermistors
- Thermo-diodes and transistors
- Thermocouples
- Light sensors
- Photo diodes
- Photo resistors
- Photo transistor

## Displacement and position sensors

Displacement sensors are basically used for the measurement of movement of an object. Position sensors are employed to determine the position of an object in relation to some reference point.

Proximity sensors are a type of position sensor and are used to trace when an object has moved within a particular critical distance of a transducer.

### Displacement sensors

#### 1. Potentiometer Sensors

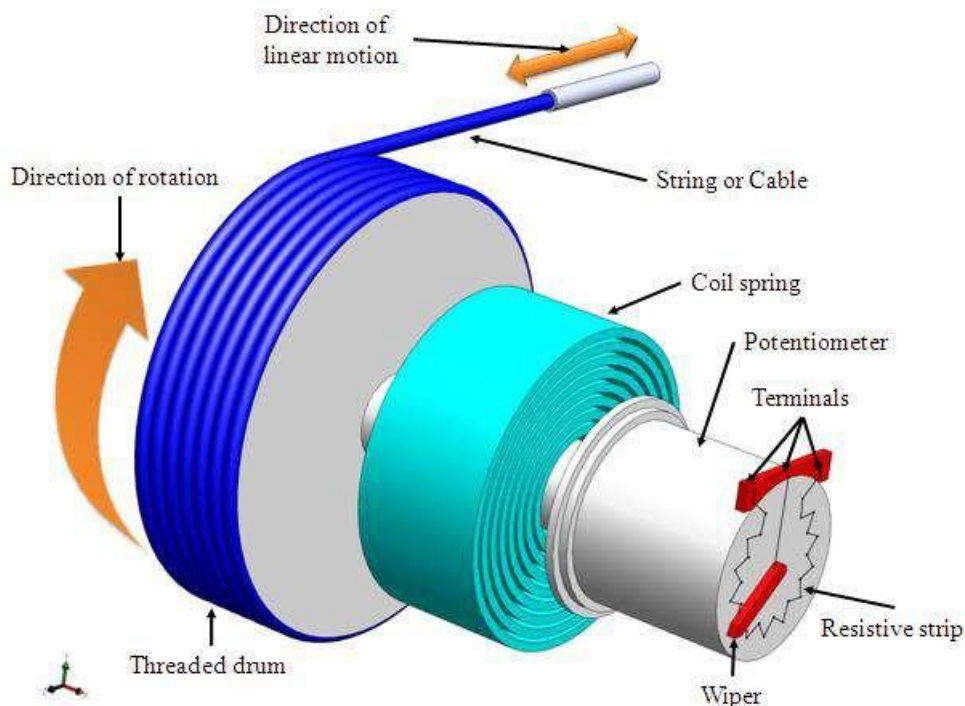

**Schematic of a potentiometer sensor for measurement of linear displacement**

Figure above shows the construction of a rotary type potentiometer sensor employed to measure the linear displacement. The potentiometer can be of linear or angular type. It works on the principle of conversion of mechanical displacement into an electrical signal. The sensor has a resistive element and a sliding contact (wiper). The slider moves along this conductive body, acting as a movable electric contact.

The object of whose displacement is to be measured is connected to the slider by using

- a rotating shaft (for angular displacement)
- a moving rod (for linear displacement)

- a cable that is kept stretched during operation

The resistive element is a wire wound track or conductive plastic. The track comprises of large number of closely packed turns of a resistive wire. Conductive plastic is made up of plastic resin embedded with the carbon powder. Wire wound track has a resolution of the order of  $\pm 0.01\%$  while the conductive plastic may have the resolution of about  $0.1\ \mu\text{m}$ .

During the sensing operation, a voltage  $V_s$  is applied across the resistive element. A voltage divider circuit is formed when slider comes into contact with the wire. The output voltage ( $V_A$ ) is measured as shown in the figure below. The output voltage is proportional to the displacement of the slider over the wire. Then the output parameter displacement is calibrated against the output voltage  $V_A$ .

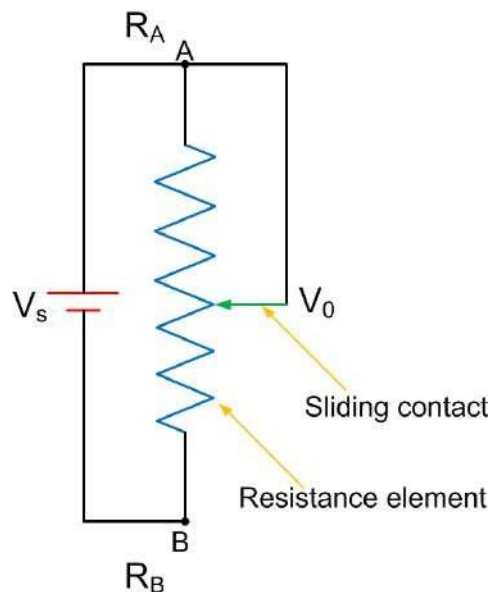

**Potentiometer: electric circuit**

### Applications of potentiometer

These sensors are primarily used in the control systems with a feedback loop to ensure that the moving member or component reaches its commanded position.

These are typically used on machine-tool controls, elevators, liquid-level assemblies, forklift trucks, automobile throttle controls. In manufacturing, these are used in control of injection molding machines, woodworking

machinery, printing, spraying, robotics, etc. These are also used in computer-controlled monitoring of sports equipment.

### **Strain Gauges**

The strain in an element is a ratio of change in length in the direction of applied load to the original length of an element. The strain changes the resistance  $R$  of the element. Therefore, we can say,

$$\Delta R/R \propto \epsilon;$$

$$\Delta R/R = G \epsilon \text{ (2.2.5)}$$

where  $G$  is the constant of proportionality and is called as gauge factor.

In general, the value of  $G$  is considered in between 2 to 4 and the resistances are taken of the order of 100  $\Omega$ .

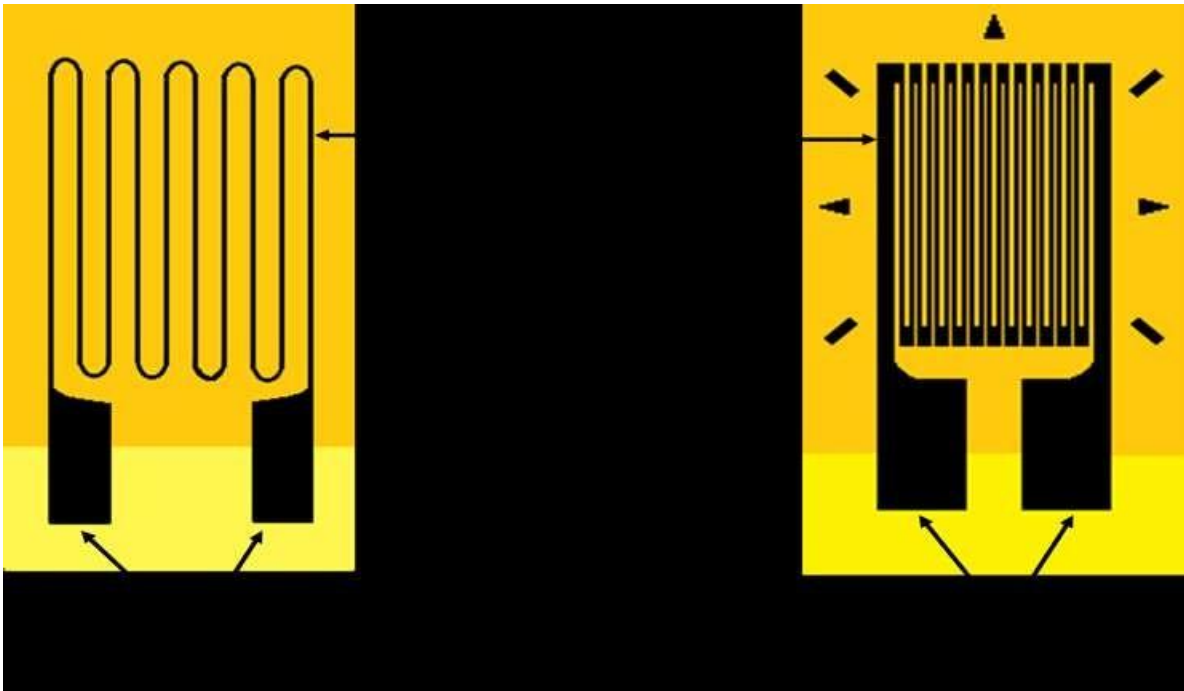

A pattern of resistive foils

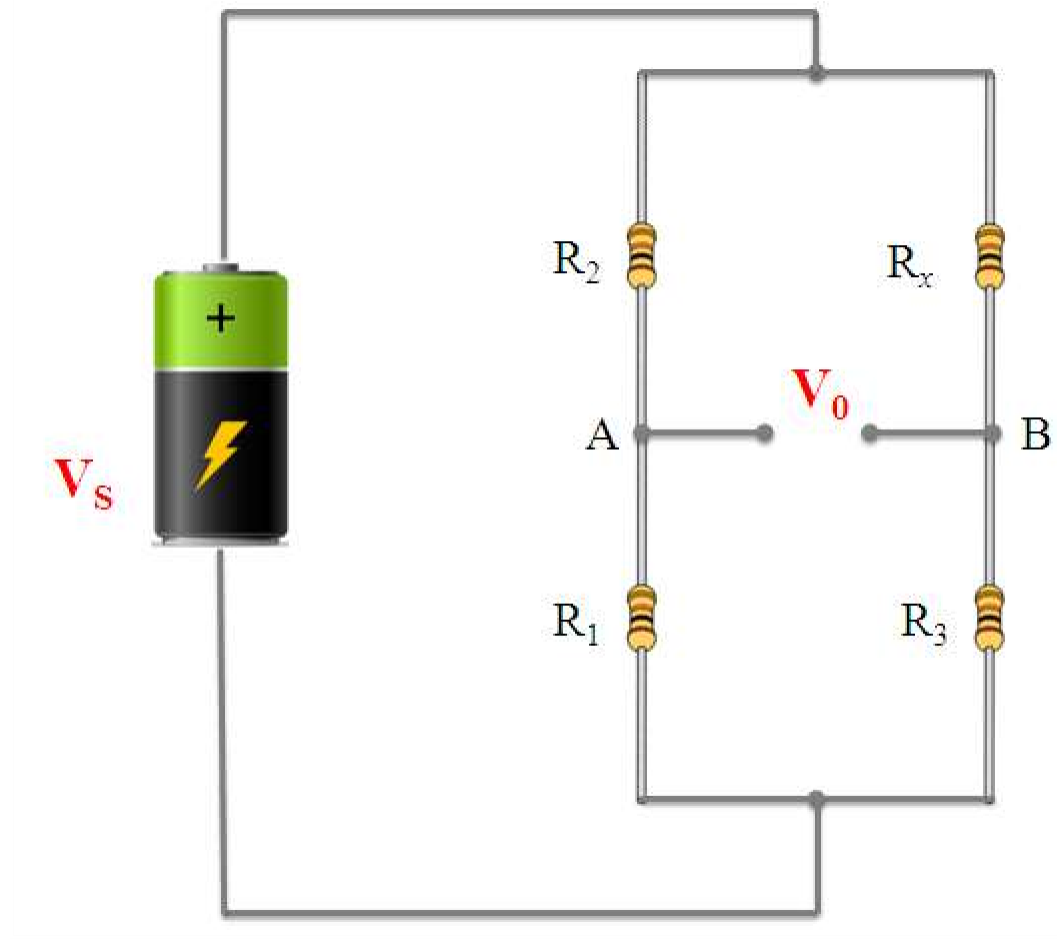

Wheatstone's bridge

Resistance strain gauge follows the principle of change in resistance as per the equation 2.2.5. It comprises of a pattern of resistive foil arranged as shown in Figure 2.2.3. These foils are made of Constantan alloy (copper-nickel 55-45% alloy) and are bonded to a backing material plastic (polyimide), epoxy or glass fiber reinforced epoxy. The strain gauges are secured to the workpiece by using epoxy or Cyanoacrylate cement Eastman 910 SL. As the workpiece undergoes change in its shape due to external loading, the resistance of strain gauge element changes. This change in resistance can be detected by using a Wheatstone's resistance bridge as shown in Figure 2.2.4. In the balanced bridge we can have a relation,

$$R_2 / R_1 = R_x / R_3$$

where  $R_x$  is resistance of strain gauge element,  $R_2$  is balancing/adjustable resistor,  $R_1$  and  $R_3$  are known constant value resistors. The measured deformation or displacement by the strain gauge is calibrated against change

in resistance of adjustable resistor  $R_2$  which makes the voltage across nodes A and B equal to zero.

### **Applications of strain gauges**

Strain gauges are widely used in experimental stress analysis and diagnosis on machines and failure analysis. They are basically used for multi-axial stress fatigue testing, proof testing, residual stress and vibration measurement, torque measurement, bending and deflection measurement, compression and tension measurement and strain measurement.

Strain gauges are primarily used as sensors for machine tools and safety in automobiles. In particular, they are employed for force measurement in machine tools, hydraulic or pneumatic press and as impact sensors in aerospace vehicles.

### **Capacitive element based sensor**

Capacitive sensor is of non-contact type sensor and is primarily used to measure the linear displacements from few millimeters to hundreds of millimeters. It comprises of three plates, with the upper pair forming one capacitor and the lower pair another. The linear displacement might take in two forms:

- a. one of the plates is moved by the displacement so that the plate separation changes
- b. area of overlap changes due to the displacement.

Figure below shows the schematic of three-plate capacitive element sensor and displacement measurement of a mechanical element connected to the plate 2.



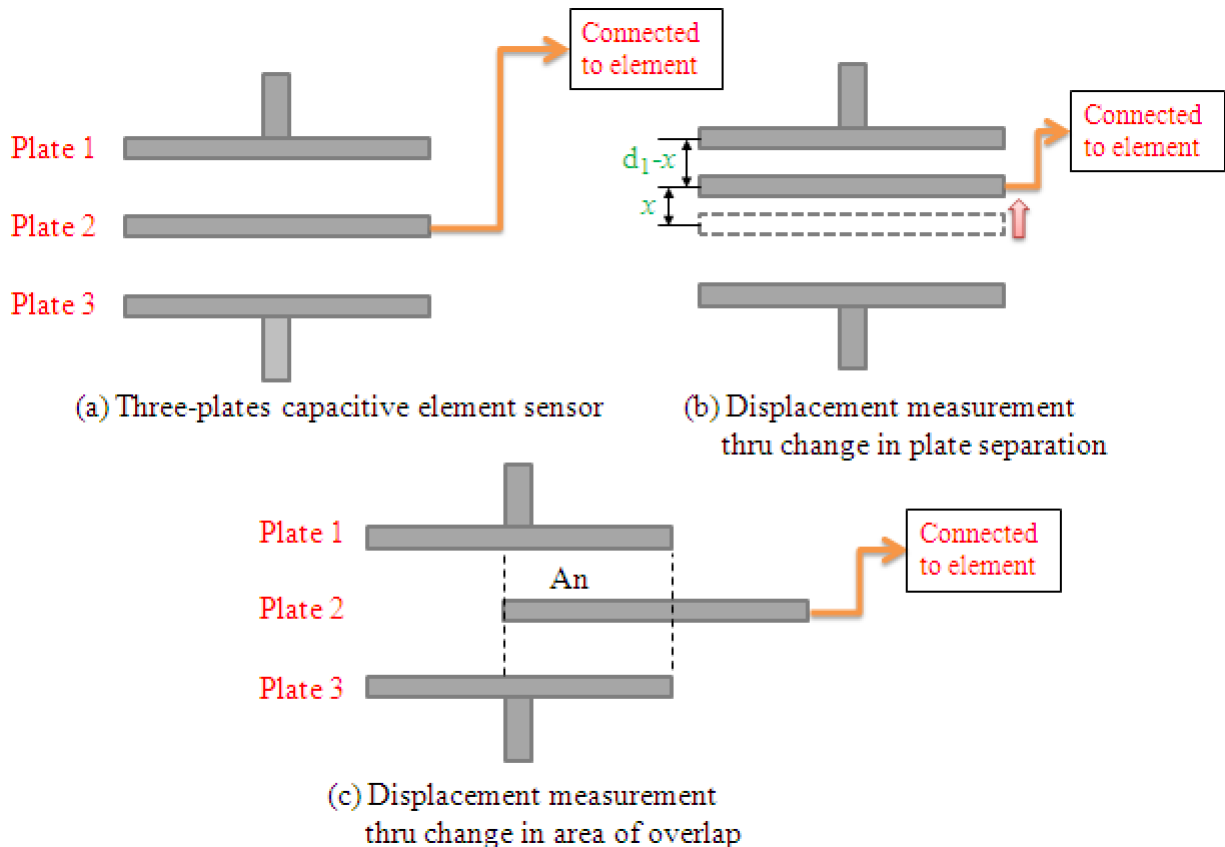

Displacement measurement using capacitive element sensor

The capacitance  $C$  of a parallel plate capacitor is given by,

$$C = \epsilon_r \epsilon_0 A / d$$

where  $\epsilon_r$  is the relative permittivity of the dielectric between the plates,  $\epsilon_0$  permittivity of free space,  $A$  area of overlap between two plates and  $d$  the plate separation.

As the central plate moves near to top plate or bottom one due to the movement of the element /workpiece of which displacement is to be measured, separation in between the plate changes. This can be given as,

$$C_1 = (\epsilon_r \epsilon_0 A) / (d + x)$$

$$C_2 = (\epsilon_r \epsilon_0 A) / (d - x)$$

When  $C_1$  and  $C_2$  are connected to a Wheatstone's bridge, then the resulting out-of-balance voltage would be in proportional to displacement  $x$ .

Capacitive elements can also be used as proximity sensor. The approach of the object towards the sensor plate is used for induction of change in plate separation. This changes the capacitance which is used to detect the object.

### Applications of capacitive element sensors

- Feed hopper level monitoring
- Small vessel pump control
- Grease level monitoring
- Level control of liquids
- Metrology applications o to measure shape errors in the part being produced
- o to analyze and optimize the rotation of spindles in various machine tools such as surface grinders, lathes, milling machines, and air bearing spindles by measuring errors in the machine tools themselves
- Assembly line testing o to test assembled parts for uniformity, thickness or other design features
- o to detect the presence or absence of a certain component, such as glue etc.

### Linear variable differential transformer (LVDT)

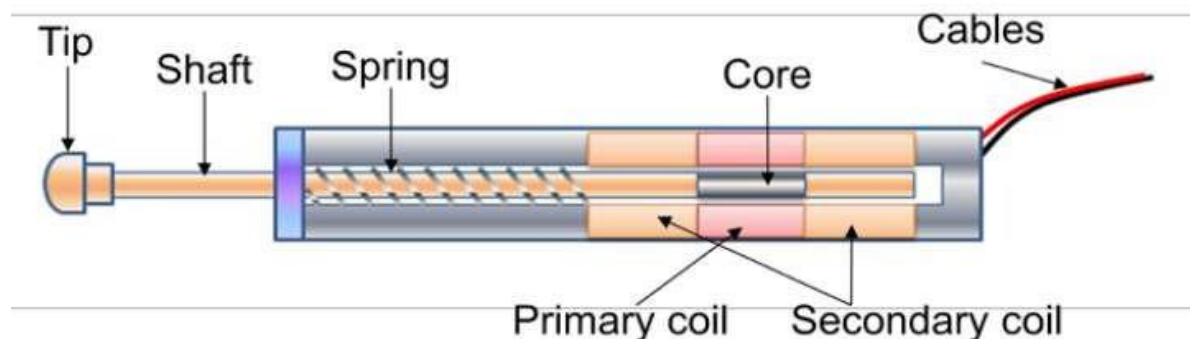

Construction of a LVDT sensor

Linear variable differential transformer (LVDT) is a primary transducer used for measurement of linear displacement with an input range of about  $\pm 2$  to  $\pm 400$  mm in general. It has non-linearity error  $\pm 0.25\%$  of full range. Figure 2.2.6 shows the construction of a LVDT sensor. It has three coils symmetrically spaced along an insulated tube. The central coil is primary coil and the other two are secondary coils. Secondary coils are connected in series in such a way that their outputs oppose each other. A magnetic core attached to the element of which displacement is to be monitored is placed inside the insulated tube.

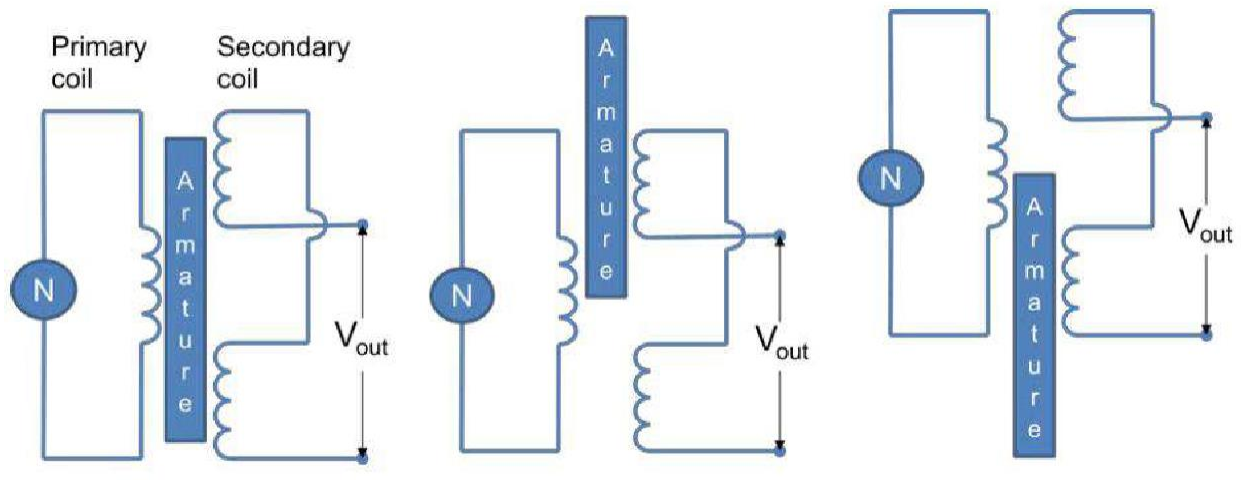

Working of LVDT sensor

Due to an alternating voltage input to the primary coil, alternating electromagnetic forces (emfs) are generated in secondary coils. When the magnetic core is centrally placed with its half portion in each of the secondary coil regions then the resultant voltage is zero. If the core is displaced from the central position as shown in Figure 2.2.7, say, more in secondary coil 1 than in coil 2, then more emf is generated in one coil i.e. coil 1 than the other, and there is a resultant voltage from the coils. If the magnetic core is further displaced, then the value of resultant voltage increases in proportion with the displacement. With the help of signal processing devices such as low pass filters and demodulators, precise displacement can be measured by using LVDT sensors.

LVDT exhibits good repeatability and reproducibility. It is generally used as an absolute position sensor. Since there is no contact or sliding between the constituent elements of the sensor, it is highly reliable. These sensors are completely sealed and are widely used in Servomechanisms, automated measurement in machine tools.

A rotary variable differential transformer (RVDT) can be used for the measurement of rotation. Readers are suggested to prepare a report on principle of working and construction of RVDT sensor.

### Applications of LVDT sensors

- Measurement of spool position in a wide range of servo valve applications
- To provide displacement feedback for hydraulic cylinders
- To control weight and thickness of medicinal products viz. tablets or pills

- For automatic inspection of final dimensions of products being packed for dispatch
- To measure distance between the approaching metals during Friction welding process
- To continuously monitor fluid level as part of leak detection system
- To detect the number of currency bills dispensed by an ATM

### Displacement, position and proximity sensors

#### *Eddy current proximity sensors*

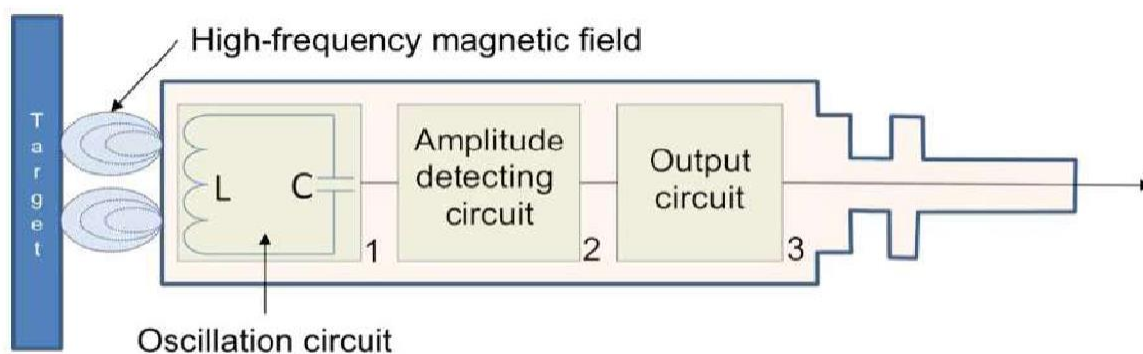

Schematic of Inductive Proximity Sensor

Eddy current proximity sensors are used to detect non-magnetic but conductive materials. They comprise of a coil, an oscillator, a detector and a triggering circuit. Figure 2.3.1 shows the construction of eddy current proximity switch. When an alternating current is passed thru this coil, an alternative magnetic field is generated. If a metal object comes in the close proximity of the coil, then eddy currents are induced in the object due to the magnetic field. These eddy currents create their own magnetic field which distorts the magnetic field responsible for their generation. As a result, impedance of the coil changes and so the amplitude of alternating current. This can be used to trigger a switch at some pre-determined level of change in current.

Eddy current sensors are relatively inexpensive, available in small in size, highly reliable and have high sensitivity for small displacements.

#### **Applications of eddy current proximity sensors**

- Automation requiring precise location
- Machine tool monitoring

- Final assembly of precision equipment such as disk drives
- Measuring the dynamics of a continuously moving target, such as a vibrating element,
- Drive shaft monitoring
- Vibration measurements

## Pneumatic Sensors

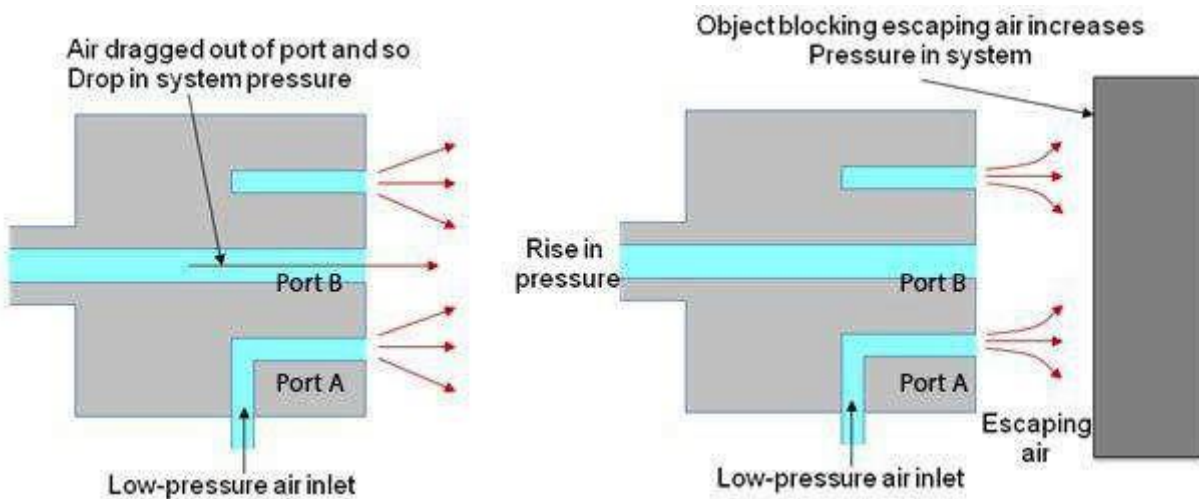

Working of Pneumatic Sensors

Pneumatic sensors are used to measure the displacement as well as to sense the proximity of an object close to it. The displacement and proximity are transformed into change in air pressure. Figure 2.3.4 shows a schematic of construction and working of such a sensor. It comprises of three ports. Low pressure air is allowed to escape through port A. In the absence of any obstacle / object, this low pressure air escapes and in doing so, reduces the pressure in the port B. However when an object obstructs the low pressure air (Port A), there is rise in pressure in output port B. This rise in pressure is calibrated to measure the displacement or to trigger a switch. These sensors are used in robotics, pneumatics and for tooling in CNC machine tools.

**Proximity Switches**

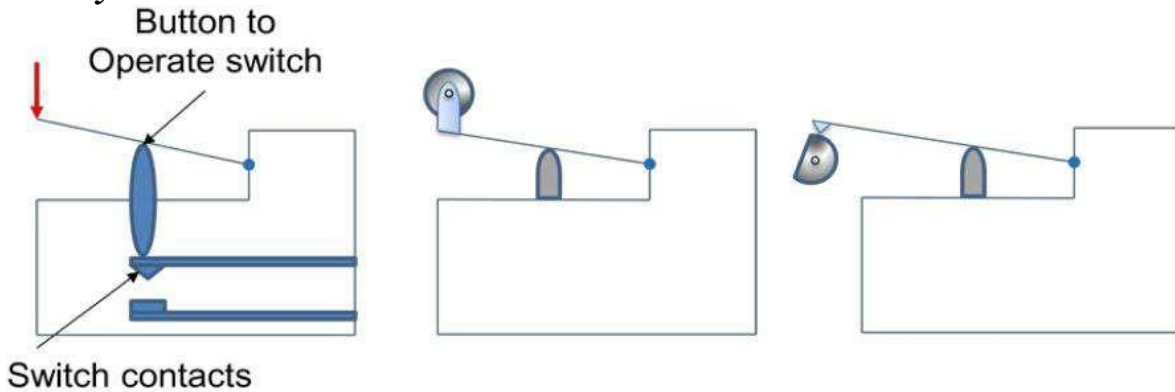

(a) Lever-operated

(b) Roller-operated

(c) Cam-operated

Figure above shows a number of configurations of contact-type proximity switch being used in manufacturing automation. These are small electrical switches which require physical contact and a small operating force to close the contacts. They are basically employed on conveyor systems to detect the presence of an item on the conveyor belt.

**Hall effect sensor**

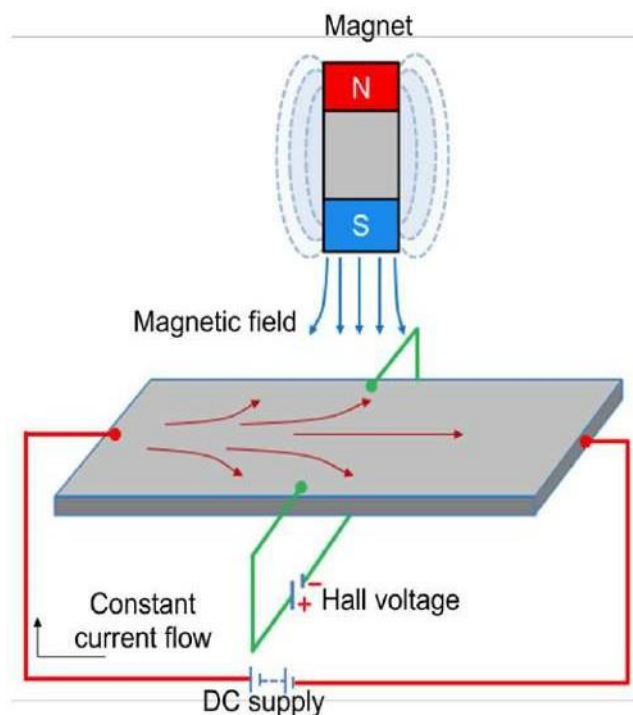

### Principle of working of Hall effect sensor

Figure above shows the principle of working of Hall effect sensor. Hall effect sensors work on the principle that when a beam of charge particles passes through a magnetic field, forces act on the particles and the current beam is deflected from its straight line path. Thus one side of the disc will become negatively charged and the other side will be of positive charge. This charge separation generates a potential difference which is the measure of distance of magnetic field from the disc carrying current.

The typical application of Hall effect sensor is the measurement of fluid level in a container. The container comprises of a float with a permanent magnet attached at its top. An electric circuit with a current carrying disc is mounted in the casing. When the fluid level increases, the magnet will come close to the disc and a potential difference generates. This voltage triggers a switch to stop the fluid to come inside the container.

These sensors are used for the measurement of displacement and the detection of position of an object. Hall effect sensors need necessary signal conditioning circuitry. They can be operated at 100 kHz. Their non-contact nature of operation, good immunity to environment contaminants and ability to sustain in severe conditions make them quite popular in industrial automation.

### Velocity, motion, force and pressure sensors

#### Tachogenerator

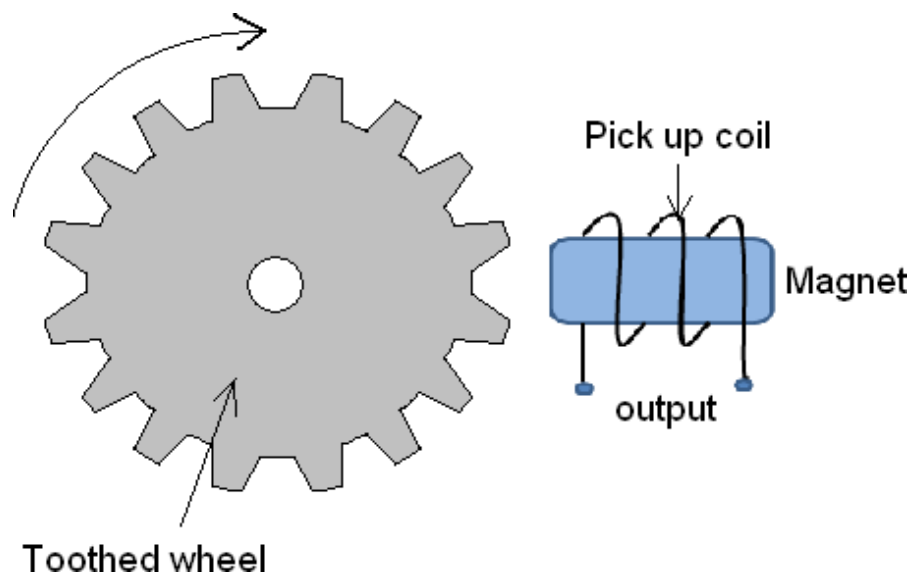

Principle of working of Techogenerator

Tachogenerator works on the principle of variable reluctance. It consists of an assembly of a toothed wheel and a magnetic circuit as shown in figure 2.4.1. Toothed wheel is mounted on the shaft or the element of which angular motion is to be measured. Magnetic circuit comprising of a coil wound on a ferromagnetic material core. As the wheel rotates, the air gap between wheel tooth and magnetic core changes which results in cyclic change in flux linked with the coil. The alternating emf generated is the measure of angular motion. A pulse shaping signal conditioner is used to transform the output into a number of pulses which can be counted by a counter.

### Pyroelectric sensors

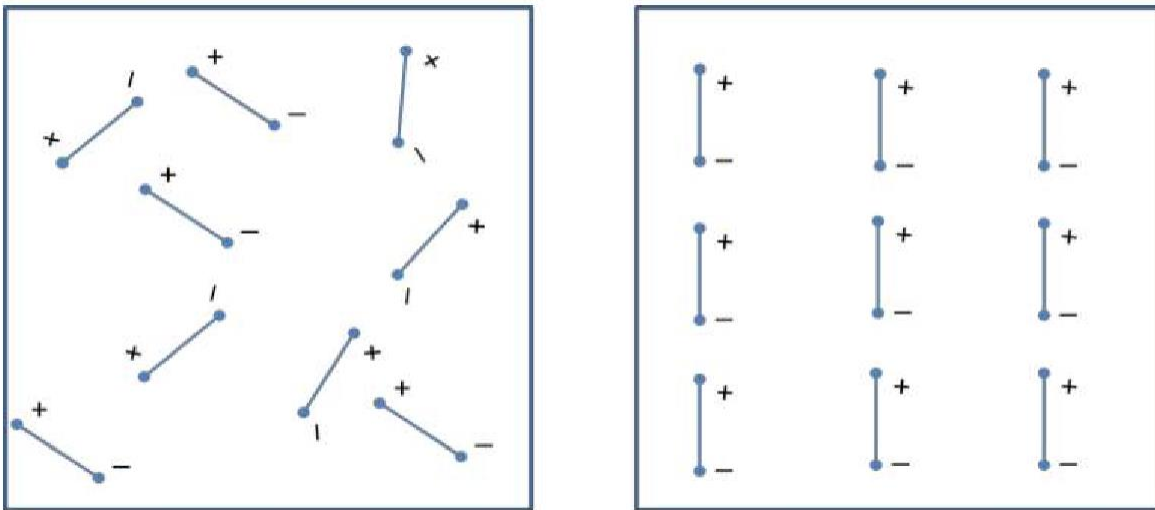

Principle of pyroelectricity

These sensors work on the principle of *pyroelectricity*, which states that a crystal material such as Lithium tantalite generates charge in response to heat flow. In presence of an electric field, when such a crystal material heats up, its electrical dipoles line up as shown in figure 2.4.3. This is called as polarization. On cooling, the material retains its polarization. In absence of electric field, when this polarized material is subjected to infrared irradiation, its polarization reduces. This phenomenon is the measure of detection of movement of an object.



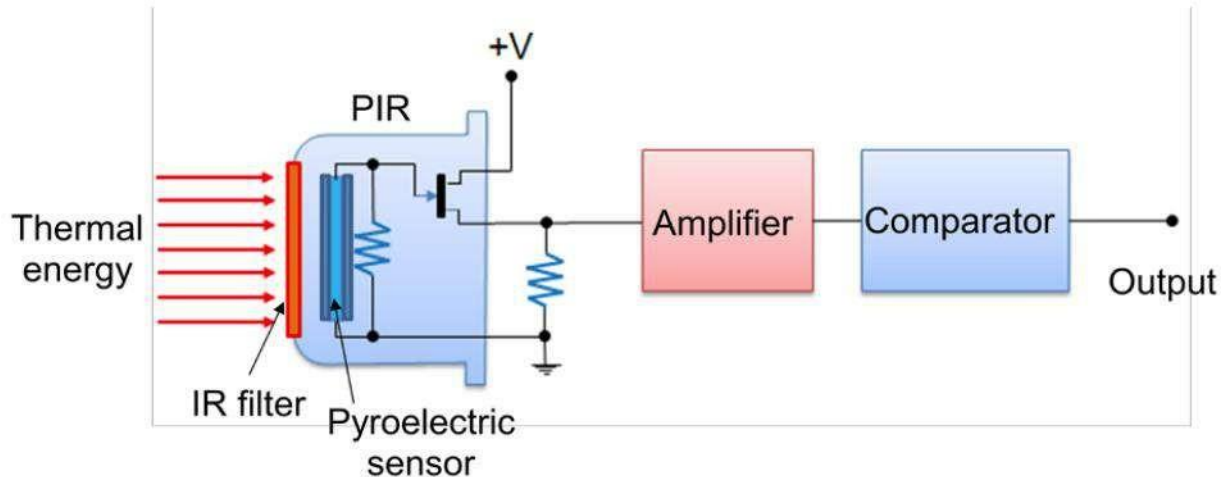

### Construction and working a Pyroelectric sensor

Pyroelectric sensor comprises of a thick element of polarized material coated with thin film electrodes on opposite faces as shown in figure 2.4.4. Initially the electrodes are in electrical equilibrium with the polarized material. On incident of infra red, the material heats up and reduces its polarization. This leads to charge imbalance at the interface of crystal and electrodes. To balance this disequilibrium, measurement circuit supplies the charge, which is calibrated against the detection of an object or its movement.

### Applications of Pyroelectric sensors

- Intrusion detector
- Optothermal detector
- Pollution detector
- Position sensor
- Solar cell studies
- Engine analysis

## Strain Gauge as force Sensor

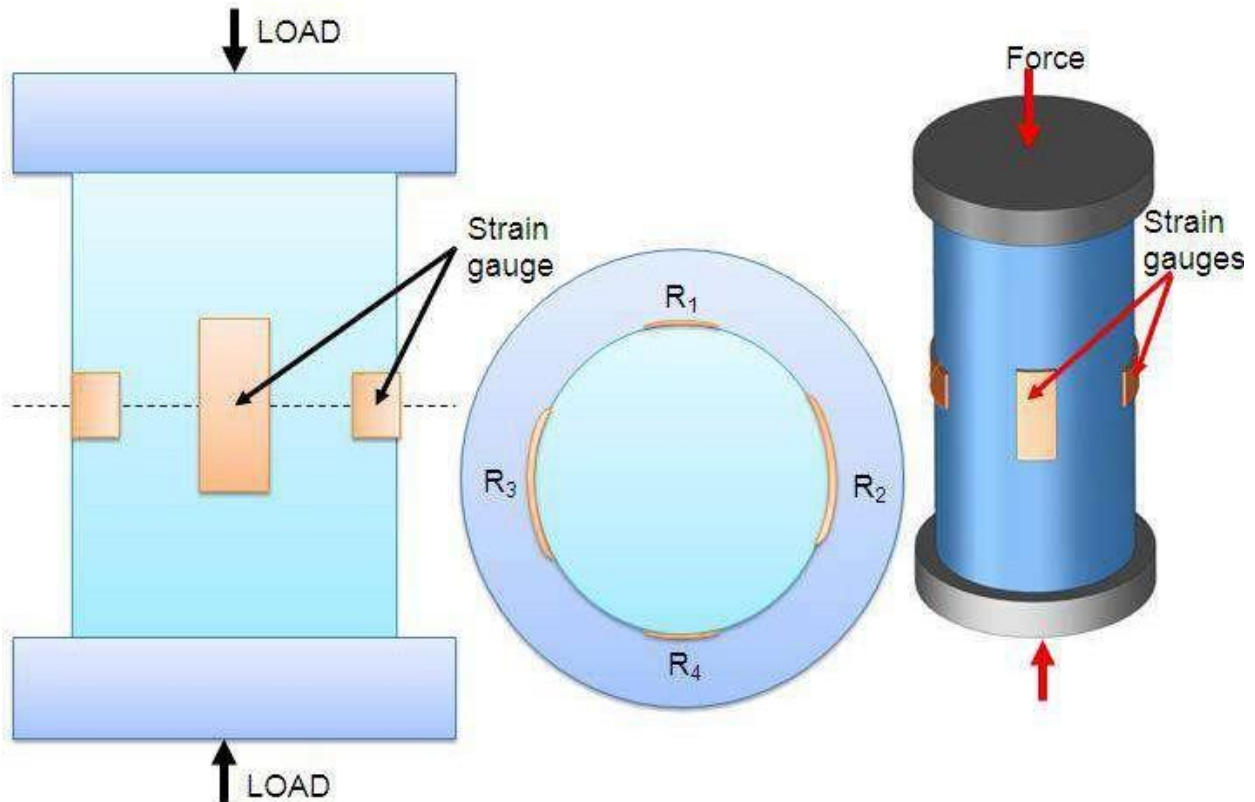

Strain gauge based Load cell

Strain gauge based sensors work on the principle of change in electrical resistance. When, a mechanical element subjects to a tension or a compression the electric resistance of the material changes. This is used to measure the force acted upon the element.

Figure above shows a strain gauge load cell. It comprises of cylindrical tube to which strain gauges are attached. A load applied on the top collar of the cylinder compress the strain gauge element which changes its electrical resistance. Generally strain gauges are used to measure forces up to 10 MN. The non-linearity and repeatability errors of this transducer are  $\pm 0.03\%$  and  $\pm 0.02\%$  respectively.

## Fluid pressure

Chemical, petroleum, power industry often need to monitor fluid pressure. Various types of instruments such as diaphragms, capsules, and bellows are used to monitor the fluid pressure. Specially designed strain gauges doped in diaphragms are generally used to measure the inlet manifold pressure in

applications such as automobiles. A typical arrangement of strain gauges on a diaphragm is shown in figure 2.4.6. Application of pressurized fluid displaces the diaphragm. This displacement is measured by the strain gauges in terms of radial and/or lateral strains. These strain gauges are connected to form the arms of a Wheatstone bridge.

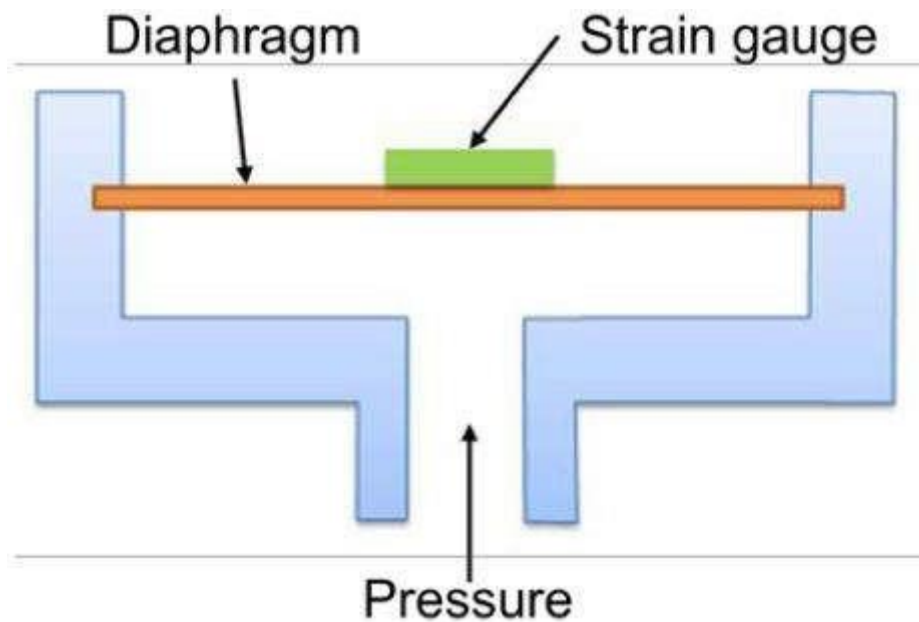

A diaphragm

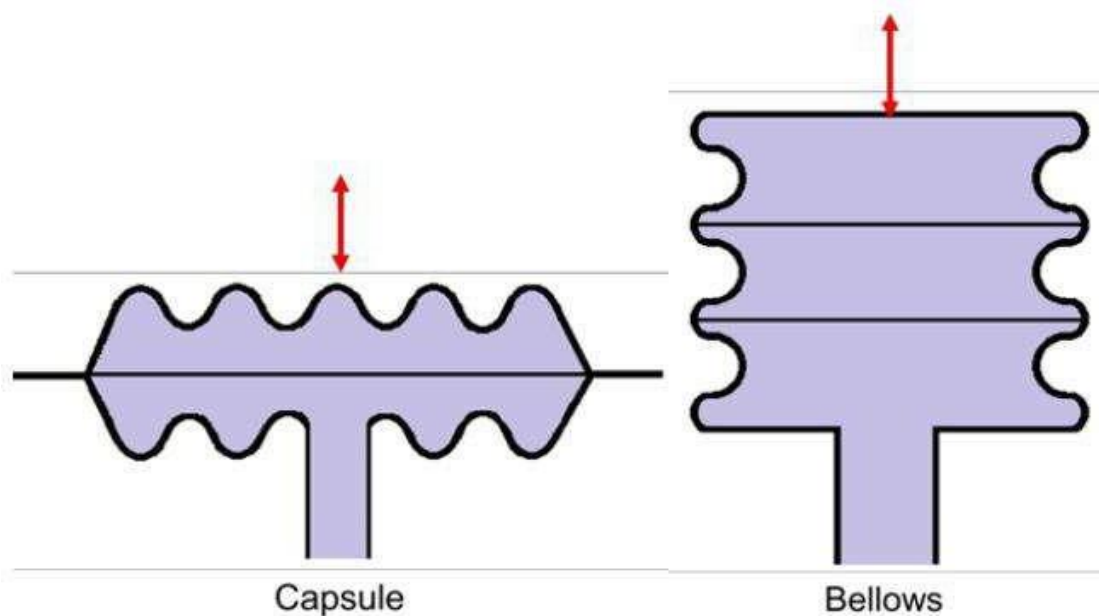

### Schematic of Capsule and Bellow

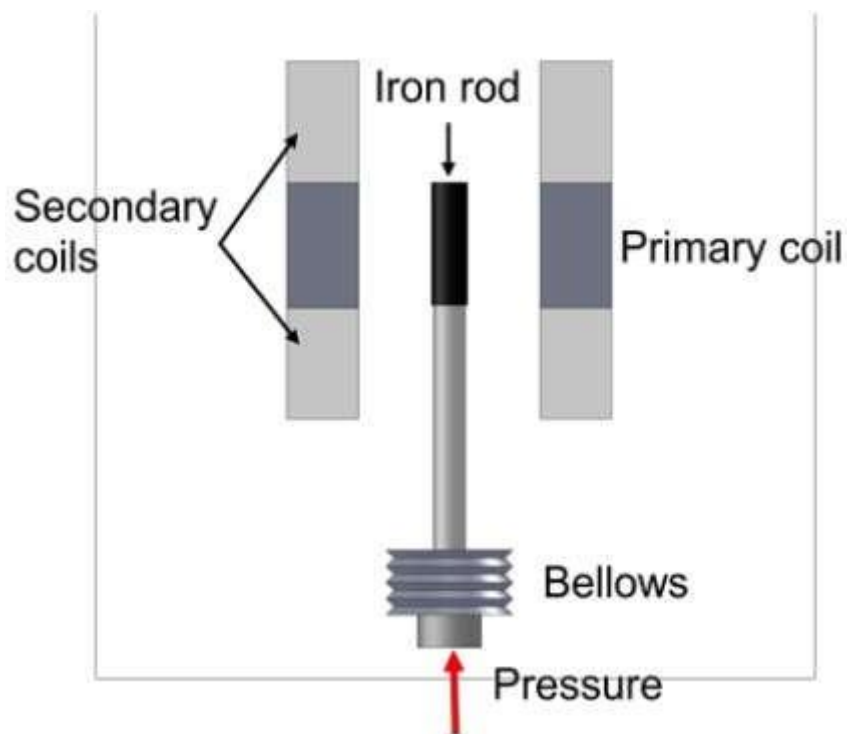

#### Bellow with a LVDT

Capsule is formed by combining two corrugated diaphragms. It has enhanced sensitivity in comparison with that of diaphragms. Figure 2.4.7 shows a schematic of a Capsule and a Bellow. A stack of capsules is called as 'Bellows'. Bellows with a LVDT sensor measures the fluid pressure in terms of change in resultant voltage across the secondary coils of LVDT. Figure above shows a typical arrangement of the same.

## Tactile sensors

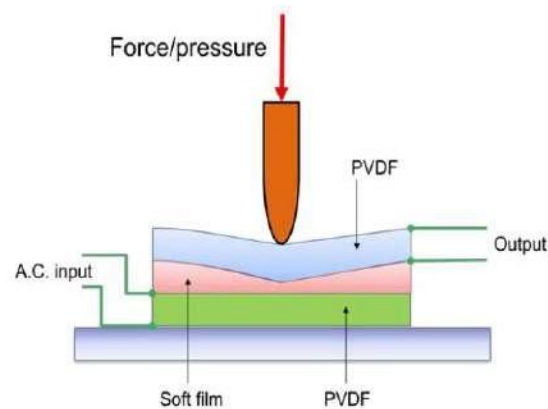

Schematic of a tactile sensor

In general, tactile sensors are used to sense the contact of fingertips of a robot with an object. They are also used in manufacturing of 'touch display' screens of visual display units (VDUs) of CNC machine tools. Figure 2.4.9 shows the construction of piezo-electric polyvinylidene fluoride (PVDF) based tactile sensor. It has two PVDF layers separated by a soft film which transmits the vibrations. An alternating current is applied to lower PVDF layer which generates vibrations due to reverse piezoelectric effect. These vibrations are transmitted to the upper PVDF layer via soft film. These vibrations cause alternating voltage across the upper PVDF layer. When some pressure is applied on the upper PVDF layer the vibrations gets affected and the output voltage changes. This triggers a switch or an action in robots or touch displays.

### Piezoelectric sensor

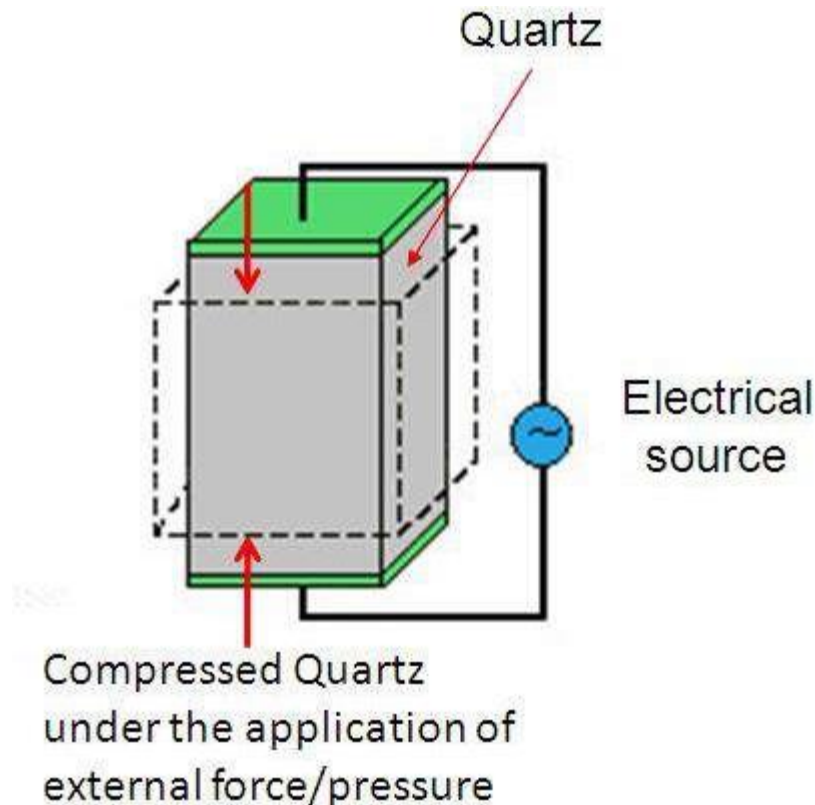

#### Principle of working of Piezoelectric sensor

Piezoelectric sensor is used for the measurement of pressure, acceleration and dynamic-forces such as oscillation, impact, or high speed compression or tension. It contains piezoelectric ionic crystal materials such as Quartz (Figure). On application of force or pressure these materials get stretched or compressed. During this process, the charge over the material changes and redistributes. One face of the material becomes positively charged and the other negatively charged. The net charge  $q$  on the surface is proportional to the amount  $x$  by which the charges have been displaced. The displacement is proportion to force. Therefore we can write,

$$q = kx = SF$$

where  $k$  is constant and  $S$  is a constant termed the charge sensitivity.

#### **Liquid flow**

Liquid flow is generally measured by applying the Bernoulli's principle of fluid flow through a constriction. The quantity of fluid flow is computed by using the pressure drop measured. The fluid flow volume is proportional to square

root of pressure difference at the two ends of the constriction. There are various types of fluid flow measurement devices being used in manufacturing automation such as Orifice plate, Turbine meter etc.

### Orifice Plate

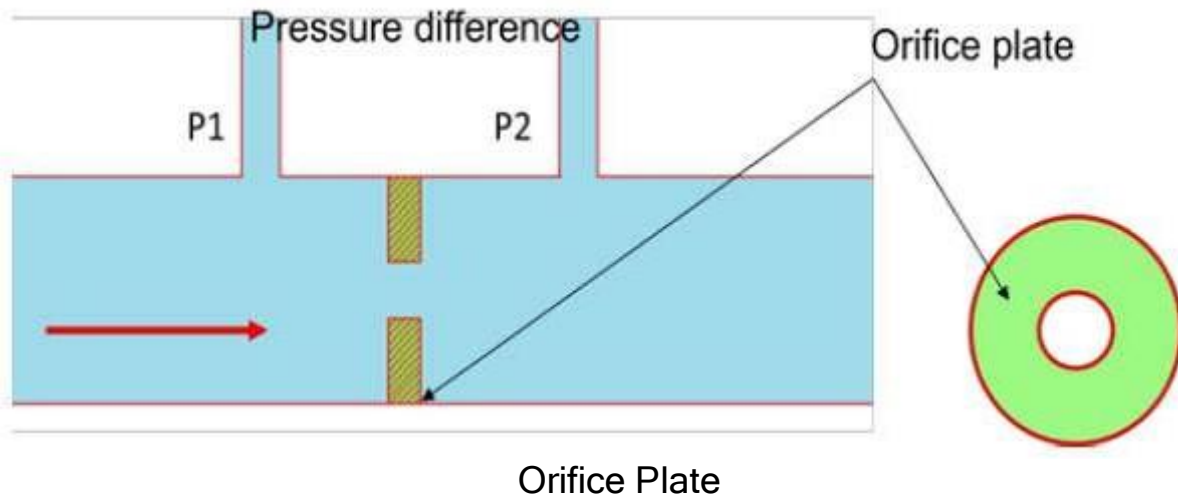

Orifice Plate

Figure above shows a schematic of Orifice plate device. It has a disc with a hole at its center, through which the fluid flows. The pressure difference is measured between a point equal to the diameter of the tube upstream and a point equal to the half the diameter downstream. Orifice plate is inexpensive and simple in construction with no moving parts. It exhibits nonlinear behavior and does not work with slurries. It has accuracy of  $\pm 1.5\%$ .

### Turbine meter

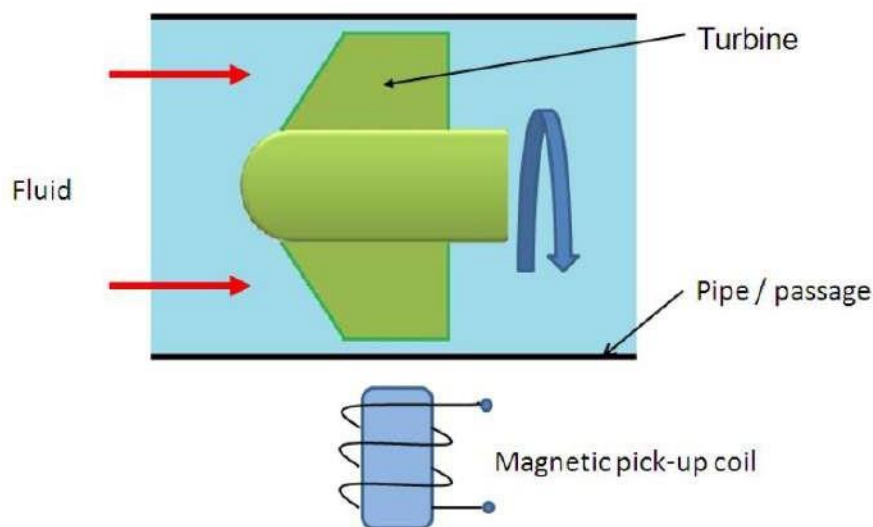

Schematic of turbine meter

Turbine flow meter has an accuracy of  $\pm 0.3\%$ . It has a multi blade rotor mounted centrally in the pipe along which the flow is to be measured. Figure 2.4.12 shows the typical arrangement of the rotor and a magnetic pick up coil. The fluid flow rotates the rotor. Accordingly the magnetic pick up coil counts the number of magnetic pulses generated due to the distortion of magnetic field by the rotor blades. The angular velocity is proportional to the number of pulses and fluid flow is proportional to angular velocity.

### **8. Fluid level**

The level of liquid in a vessel or container can be measured,

- a. directly by monitoring the position of liquid surface
- b. indirectly by measuring some variable related to the height.

Direct measurements involve the use of floats however the indirect methods employ load cells. Potentiometers or LVDT sensors can be used along with the floats to measure the height of fluid column. Force sensed by the load cells is proportional to the height of fluid column.

### **Temperature and light sensors**

Temperature conveys the state of a mechanical system in terms of expansion or contraction of solids, liquids or gases, change in electrical resistance of conductors, semiconductors and thermoelectric emfs. Temperature sensors such as bimetallic strips, thermocouples, thermistors are widely used in monitoring of manufacturing processes such as casting, molding, metal cutting etc. The construction details and principle of working of some of the temperature sensors are discussed in following sections.

#### **1. Bimetallic strips**



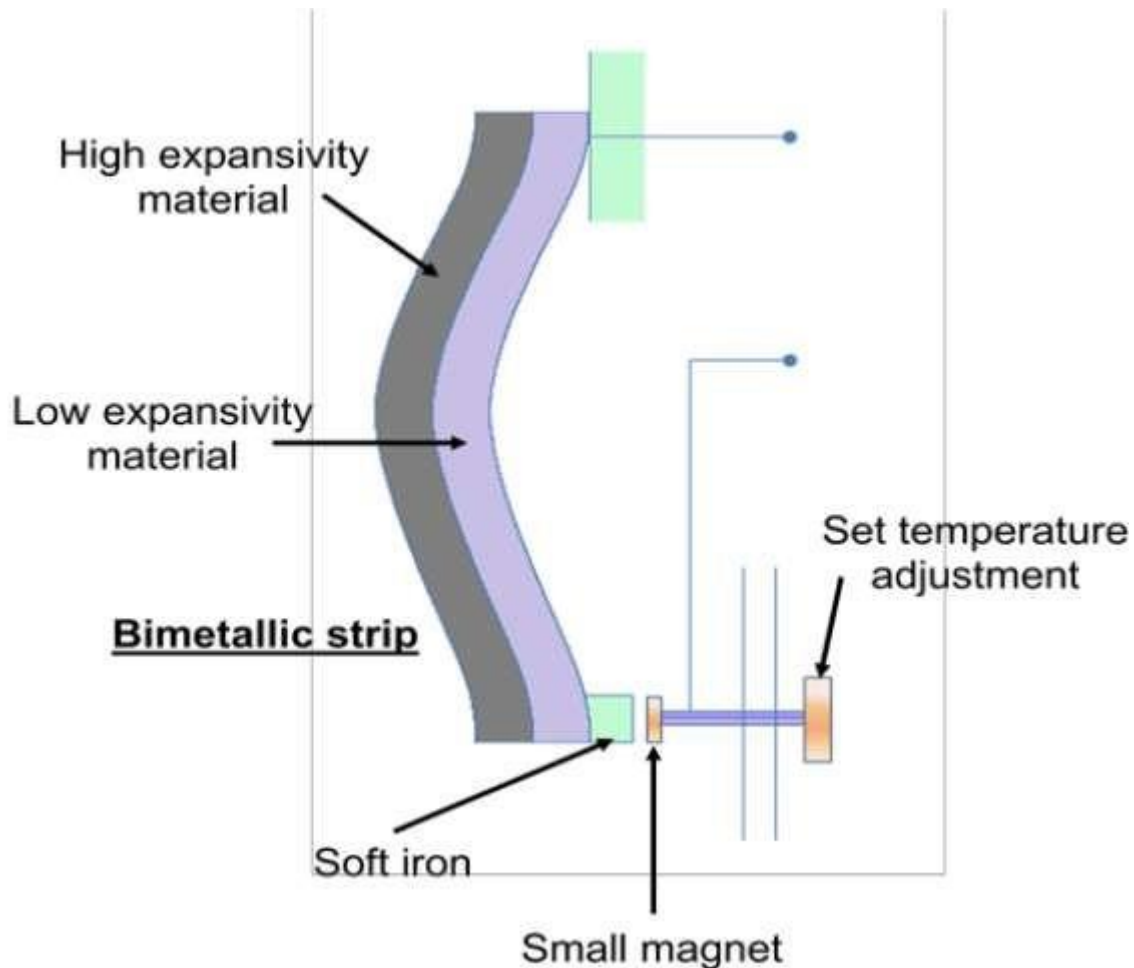

Construction and working of Bi-metallic strip

Bimetallic strips are used as thermal switch in controlling the temperature or heat in a manufacturing process or system. It contains two different metal strips bonded together. The metals have different coefficients of expansion. On heating the strips bend into curved strips with the metal with higher coefficient of expansion on the outside of the curve. Figure 2.5.1 shows a typical arrangement of a bimetallic strip used with a setting-up magnet. As the strips bend, the soft iron comes in closer proximity of the small magnet and further touches. Then the electric circuit completes and generates an alarm. In this way bimetallic strips help to protect the desired application from heating above the pre-set value of temperature.

## **2. Resistance temperature detectors (RTDs)**

RTDs work on the principle that the electric resistance of a metal changes due to change in its temperature. On heating up metals, their resistance

increases and follows a linear relationship as shown in Figure 2.5.2. The correlation is

$$R_t = R_0 (1 + \alpha T) \quad (2.5.1)$$

where  $R_t$  is the resistance at temperature  $T$  ( $^{\circ}\text{C}$ ) and  $R_0$  is the resistance at  $0^{\circ}\text{C}$  and  $\alpha$  is the constant for the metal termed as temperature coefficient of resistance. The sensor is usually made to have a resistance of  $100 \Omega$  at  $0^{\circ}\text{C}$

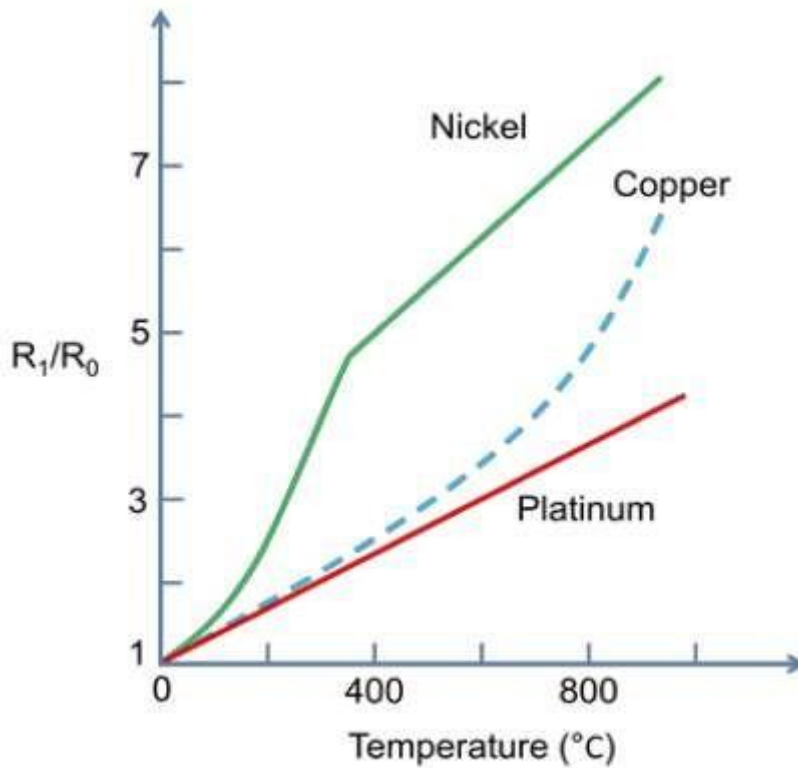

Behavior of RTD materials

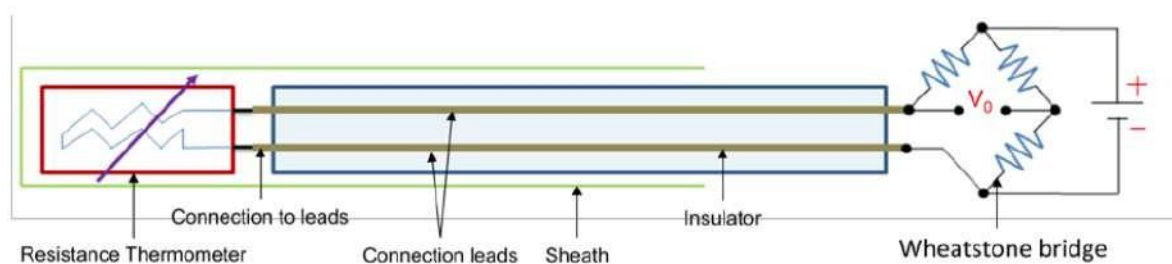

Construction of a Resistance temperature detector (RTD)

Figure above shows the construction of a RTD. It has a resistor element connected to a Wheatstone bridge. The element and the connection leads are insulated and protected by a sheath. A small amount of current is continuously passing through the coil. As the temperature changes the resistance of the coil changes which is detected at the Wheatstone bridge. RTDs are used in the form of thin films, wire wound or coil. They are generally made of metals such as platinum, nickel or nickel-copper alloys. Platinum wire held by a high-temperature glass adhesive in a ceramic tube is used to measure the temperature in a metal furnace. Other applications are:

- Air conditioning and refrigeration servicing
- Food Processing
- Stoves and grills
- Textile production
- Plastics processing
- Petrochemical processing
- Micro electronics
- Air, gas and liquid temperature measurement in pipes and tanks
- Exhaust gas temperature measurement

### **3. Thermistors**

Thermistors follow the principle of decrease in resistance with increasing temperature. The material used in thermistor is generally a semiconductor material such as a sintered metal oxide (mixtures of metal oxides, chromium, cobalt, iron, manganese and nickel) or doped polycrystalline ceramic containing barium titanate ( $\text{BaTiO}_3$ ) and other compounds. As the temperature of semiconductor material increases the number of electrons able to move about increases which results in more current in the material and reduced resistance. Thermistors are rugged and small in dimensions. They exhibit nonlinear response characteristics.

Thermistors are available in the form of a bead (pressed disc), probe or chip. Figure 2.5.4 shows the construction of a bead type thermistor. It has a small bead of dimension from 0.5 mm to 5 mm coated with ceramic or glass material. The bead is connected to an electric circuit through two leads. To protect from the environment, the leads are contained in a stainless steel tube.

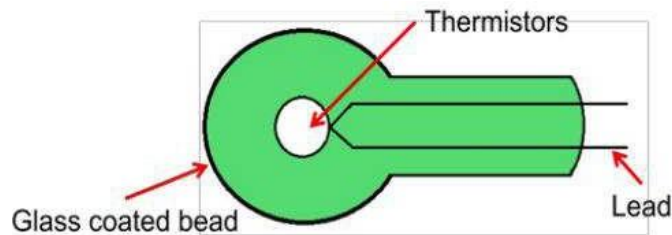

### Schematic of a thermistor Applications of Thermistors

- To monitor the coolant temperature and/or oil temperature inside the engine
- To monitor the temperature of an incubator
- Thermistors are used in modern digital thermostats
- To monitor the temperature of battery packs while charging
- To monitor temperature of hot ends of 3D printers
- To maintain correct temperature in the food handling and processing industry equipments
- To control the operations of consumer appliances such as toasters, coffee makers, refrigerators, freezers, hair dryers, etc.

#### 4. Thermocouple

Thermocouple works on the fact that when a junction of dissimilar metals heated, it produces an electric potential related to temperature. As per Thomas Seebeck (1821), when two wires composed of dissimilar metals are joined at both ends and one of the ends is heated, then there is a continuous current which flows in the thermoelectric circuit. Figure 2.5.5 shows the schematic of thermocouple circuit. The net open circuit voltage (the Seebeck voltage) is a function of junction temperature and composition of two metals. It is given by,

$$\Delta V_{AB} = \alpha \Delta T \quad (2.5.2)$$

where  $\alpha$ , the Seebeck coefficient, is the constant of proportionality.

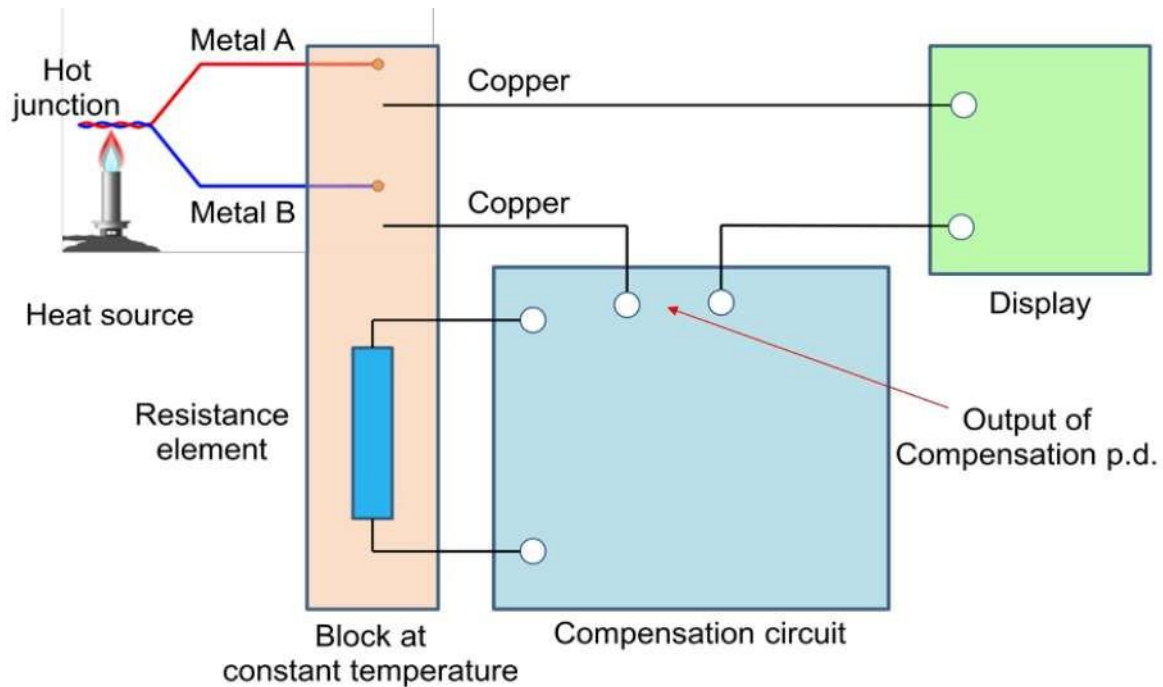

Schematic of thermocouple circuit

Generally, Chromel (90% nickel and 10% chromium)-Alumel (95% nickel, 2% manganese, 2% aluminium and 1% silicon) are used in the manufacture of a thermocouple. Table 2.5.1 shows the various other materials, their combinations and application temperature ranges.

Materials	Range (°C)	( $\mu\text{V}/^\circ\text{C}$ )
Platinum 30% rhodium/platinum 6% rhodium	0 to 1800	3
Chromel/constantan	-200 to 1000	63
Iron/constantan	-200 to 900	53
Chromel/alumel	-200 to 1300	41
Nirosil/nisil	-200 to 1300	28
Platinum/platinum 13% rhodium	0 to 1400	6
Platinum/platinum 10% rhodium	0 to 1400	6
Copper/constantan	-200 to 400	43

Thermo couple material and Temperature range

### Applications of Thermocouples

- To monitor temperatures and chemistry throughout the steel making process

- Testing temperatures associated with process plants e.g. chemical production and petroleum refineries
- Testing of heating appliance safety
- Temperature profiling in ovens, furnaces and kilns
- Temperature measurement of gas turbine and engine exhausts
- Monitoring of temperatures throughout the production and smelting process in the steel, iron and aluminum industry

### **Light sensors**

A light sensor is a device that is used to detect light. There are different types of light sensors such as photocell/photoresistor and photo diodes being used in manufacturing and other industrial applications.

Photoresistor is also called as light dependent resistor (LDR). It has a resistor whose resistance decreases with increasing incident light intensity. It is made of a high resistance semiconductor material, cadmium sulfide (CdS). The resistance of a CdS photoresistor varies inversely to the amount of light incident upon it. Photoresistor follows the principle of photoconductivity which results from the generation of mobile carriers when photons are absorbed by the semiconductor material.

Figure 2.5.6 shows the construction of a photo resistor. The CdS resistor coil is mounted on a ceramic substrate. This assembly is encapsulated by a resin material. The sensitive coil electrodes are connected to the control system through lead wires. On incidence of high intensity light on the electrodes, the resistance of resistor coil decreases which will be used further to generate the appropriate signal by the microprocessor via lead wires.

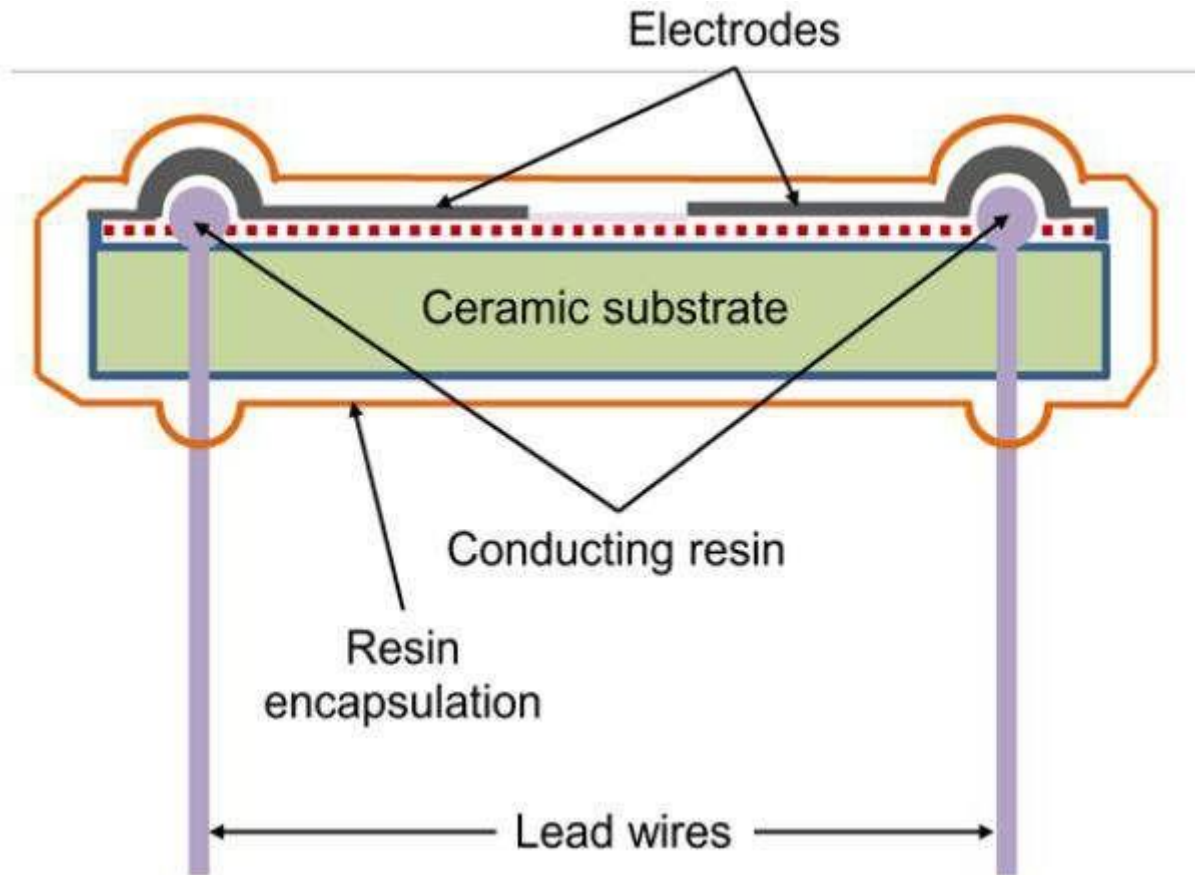

#### Construction of a photo resistor

Photoresistors are used in science and in almost any branch of industry for control, safety, amusement, sound reproduction, inspection and measurement.

#### Applications of photo resistor

- Computers, wireless phones, and televisions, use ambient light sensors to automatically control the brightness of a screen
- Barcode scanners used in retailer locations work using light sensor technology
- In space and robotics: for controlled and guided motions of vehicles and robots. The light sensor enables a robot to detect light. Robots can be programmed to have a specific reaction if a certain amount of light is detected.
- Auto Flash for camera
- Industrial process control

#### Photo diodes

Photodiode is a solid-state device which converts incident light into an electric current. It is made of Silicon. It consists of a shallow diffused p-n junction,

normally a p-on-n configuration. When photons of energy greater than 1.1eV (the bandgap of silicon) fall on the device, they are absorbed and electron-hole pairs are created. The depth at which the photons are absorbed depends upon their energy. The lower the energy of the photons, the deeper they are absorbed. Then the electron-hole pairs drift apart. When the minority carriers reach the junction, they are swept across by the electric field and an electric current establishes

Photodiodes are one of the types of photodetector, which convert light into either current or voltage. These are regular semiconductor diodes except that they may be either exposed to detect vacuum UV or X-rays or packaged with an opening or optical fiber connection to allow light to reach the sensitive part of the device.

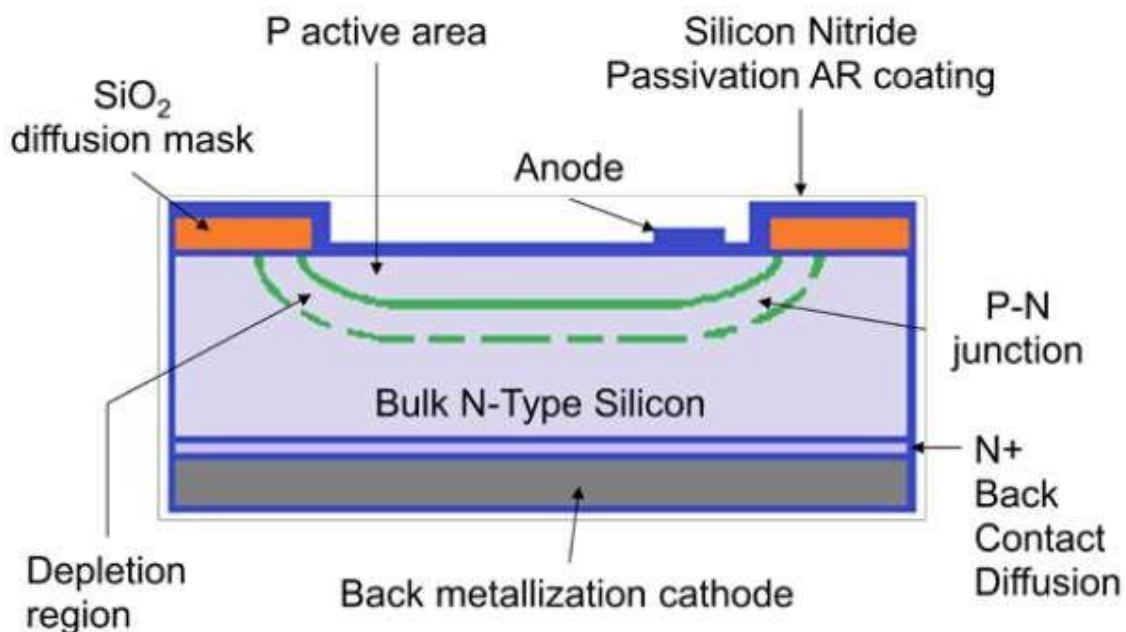

#### Construction of photo diode detector

Figure 2.5.7 shows the construction of Photo diode detector. It is constructed from single crystal silicon wafers. It is a p-n junction device. The upper layer is p layer. It is very thin and formed by thermal diffusion or ion implantation of doping material such as boron. Depletion region is narrow and is sandwiched between p layer and bulk n type layer of silicon. Light irradiates at front surface, anode, while the back surface is cathode. The incidence of light on anode generates a flow of electron across the p-n junction which is the measure of light intensity.

#### Applications of photo diodes



**Camera:** Light Meters, Automatic Shutter Control, Auto-focus, Photographic Flash Control

**Medical:** CAT Scanners - X ray Detection, Pulse Oximeters, Blood Particle Analyzers

**Industry**

- Bar Code Scanners
- Light Pens
- Brightness Controls
- Encoders
- Position Sensors
- Surveying Instruments
- Copiers - Density of Toner

**Safety Equipment**

- Smoke Detectors
- Flame Monitors
- Security Inspection Equipment - Airport X ray
- Intruder Alert - Security System

**Automotive**

- Headlight Dimmer
- Twilight Detectors
- Climate Control - Sunlight Detector

**Communications**

- Fiber Optic Links
- Optical Communications
  - Optical Remote Control

**Module-III**

Signals, systems and Actuating Devices: Introduction to signals, systems and control system, representation, linearization of nonlinear systems, time Delays, measures of system performance, types of actuating devices selection. ;

**SIGNAL:**

- One can note that what is really being received through sensor and what is being directed to the actuator is simply the 'signal'.
- A signal is a time varying quantity conveying some information.
- The transducer output is simply the 'signal' and the actuator input is also 'signal'.
- Examples of signal include:
  - Electrical signals

- Voltages and currents in a circuit
- Acoustic signals
  - Acoustic pressure (sound) over time
- Mechanical signals
  - Velocity of a car over time
- Video signals
  - Intensity level of a pixel (camera, video) over time

**How is a Signal Represented?**

- Mathematically, signals are represented as a function of one or more **independent variables**.
- For instance a black & white video signal intensity is dependent on  $x, y$  coordinates and time  $tf(x,y,t)$

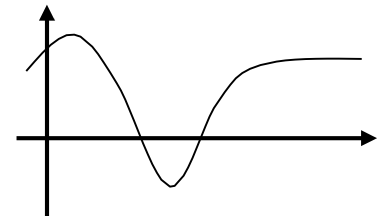

**Types of Signals**

- **Periodic signals:** a signal is periodic if it repeats itself after a fixed period  $T$ , i.e.  $X(t) = x(t+T)$  for all  $t$ . A  $\sin(t)$  signal is periodic.

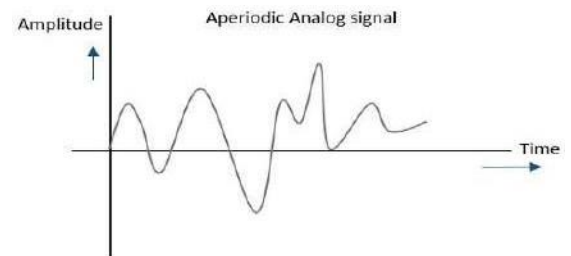
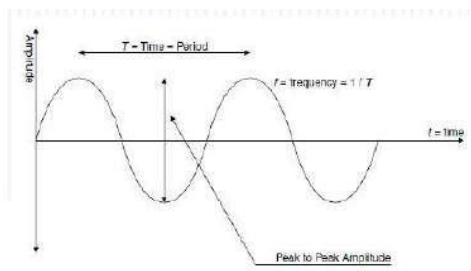

- **Even and odd signals:** a signal is even if  $x(-t) = x(t)$  (i.e. It can be reflected in the axis at zero). A signal is odd if  $x(-t) = -x(t)$ . Examples are  $\cos(t)$  and  $\sin(t)$  signals, respectively.

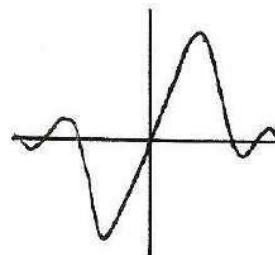
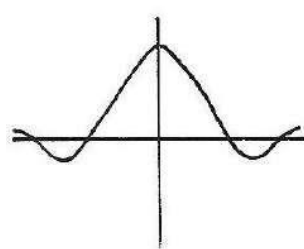

- **Deterministic signal:** completely predictable, can be a deterministic function of the variables.
  - E.g.,  $\sin(t)$ ,  $\cos(t)$ ...
- **Random signal:** cannot predict the future values of the signal exactly; evolves uncertainties. Can only be described with statistical observations, the probability of the value at certain position.
  - E.g., noise, vibration, stock market...

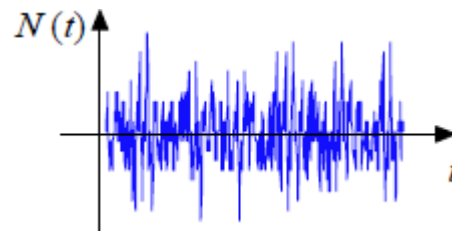

- **Continuous-time signal**  
It defined in the continuous time period. It is a function of a continuous independent variable. Note that the “continuous” refers to the variable  $t$ . The amplitude could be either continuous or discontinuous.
- **Digital signal**  
Digital signal is the signal that is both discrete in time, and quantized in amplitude.
- **Discrete-time signal**  
It defined only at a discrete set of values of independent variables. It can be obtained by sampling the continuous signal. Digital signal processing requires a discrete-time signal representation.

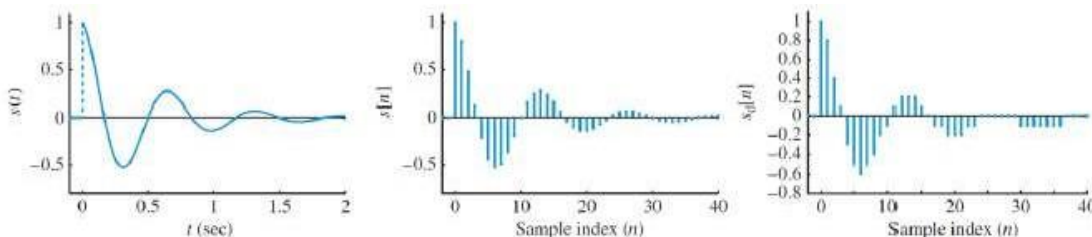

Why signal processing?

- A signal is composed is composed of many components.

- Analysis that are being carried out is to know the amplitude, frequency, and phase of the components either at a particular point of time and/or in an interval.
- In order to take advantage of processing power of modern digital processors or computers, it is necessary to convert the real world analog signals in to an appropriate form, which can be stored and processed by the use of digital systems and devices.
- Efficient make use of information, e.g. amplify or filter out information, detect patterns, different domain information
- Better transmission and processing, e.g. distortions, prevent interference

### **SYSTEM:**

- A system (or plant) is a naturally occurring or man-made entity which transforms cause(or inputs) into effects(or outputs).
- System behaviour can be modified by interactions with other systems.

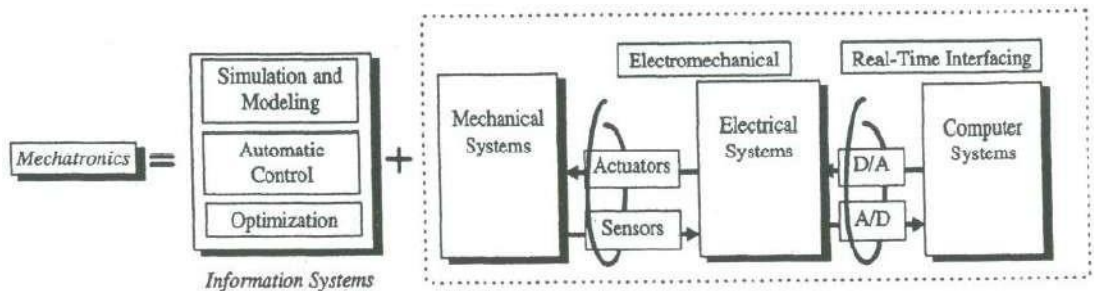

- A cd player takes the signal on the cd and transforms it into a signal sent to the loud speaker.

### **CONTROL SYSTEM:**

A control system is a collection of components that is designed to drive a given system (plant) with a given input to a desired output.

In a control system there is an interconnection between the constituent components. These components may be electrical, mechanical, hydraulic, pneumatic, etc.

- Modification of the behaviour of a system such that a desired behaviour is achieved is called control.
- Controls are implemented by attaching a controller or compensator to the plant. The resulting combined system is called a control system.

- Control systems incorporate either human or machine controllers. When the controller is machine based, it is called automatic control.
- Within any control system there are variables and functions.
- Variables can be either constant or may vary with respect to some independent variable.
  - Constant variables are called *parameters*.
  - Varying variables are called **signals**.

Basic function of a control system are:

- To minimise the error between the actual and desired output.
- To minimise the time response to load changes in the system.

Requirement of a control system:

- **Stability:** for any change in the input signal, the output of the system reads or makes its response at a reasonable value.
- **Accuracy:** the closeness of the measured value to the true value is known as accuracy.
- **Response:** the quickness with which an instrument responds to a change in the output signal is known as response.
- **Sensitivity:** The sensitivity measures how much change is caused in the output by small changes to the reference input.

## CLASSIFICATION OF CONTROL SYSTEM: OPEN LOOP CONTROL SYSTEM

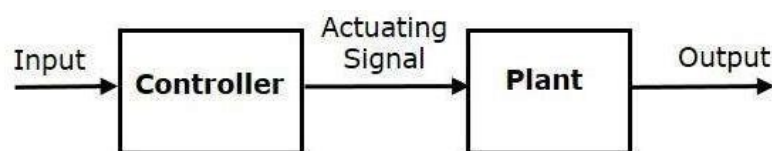

The term open-loop comes from the fact that the fact that the output only depends on the inputs. This is a complete system by itself. The control system takes the input from the controller in order to produce output by the action of the plant. The relation between the input and output are mentioned in terms of transfer function, which is defined as the ratio between the Laplace transform of the output and the Laplace transform

of the input. If the output is proportional to the input, the plant is called a linear system.

In a basic open-loop control system the controller takes the reference input called setpoint and outputs a control signal to the plant or process. This configuration is also called feed-forward open-loop control system. The controller is designed and turned using accurate model of the plant. Any inaccuracy in the system model results discrepancy in the desired output response.

### 1.1.1 CLOSED LOOP CONTROL SYSTEM

A closed-loop control system, on the other hand, uses input as well

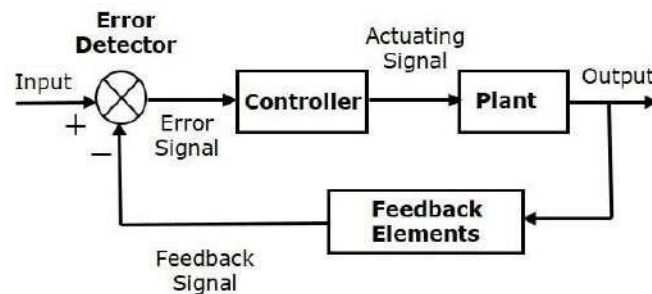

as some portion of the output to regulate the output. Closed-loop systems are also called feedback control system. In feedback control the variable required to be controlled is measured. This measurement is compared with a given setpoint. If the error results, the controller takes this error and decides what action should be taken to compensate to remove the error. Errors occur when an operator changes the setpoint intentionally or when a process load changes the process variable accidentally. The error could be positive or negative.

## ACTUATOR

### What is an Actuator?

- An actuator is a component of a machine that is responsible for moving and controlling a mechanism or system, for example by opening a valve. In simple terms, it is a "mover".
- An actuator requires a control signal and a source of energy. The control signal is relatively low energy and may be electric voltage or current,

pneumatic or hydraulic pressure, or even human power. Its main energy source may be an electric current, hydraulic fluid pressure, or pneumatic pressure. When it receives a control signal, an actuator responds by converting the signal's energy into mechanical motion.

- An actuator is the mechanism by which a control system acts upon an environment. The control system can be simple (a fixed mechanical or electronic system), software-based (e.g. a printer driver, robot control system), a human, or any other input.

### Different Types of Actuators

- Mechanical Actuator
- Pneumatic Actuator
- Hydraulic Actuator
- Electrical Actuator
- Hybrid Actuator

#### Mechanical Actuator:

In mechanical actuators normally a rotary motion is converted into linear motion to perform an operation. Such actuator normally involves gears, rails, pulley, chain, springs etc to operate.

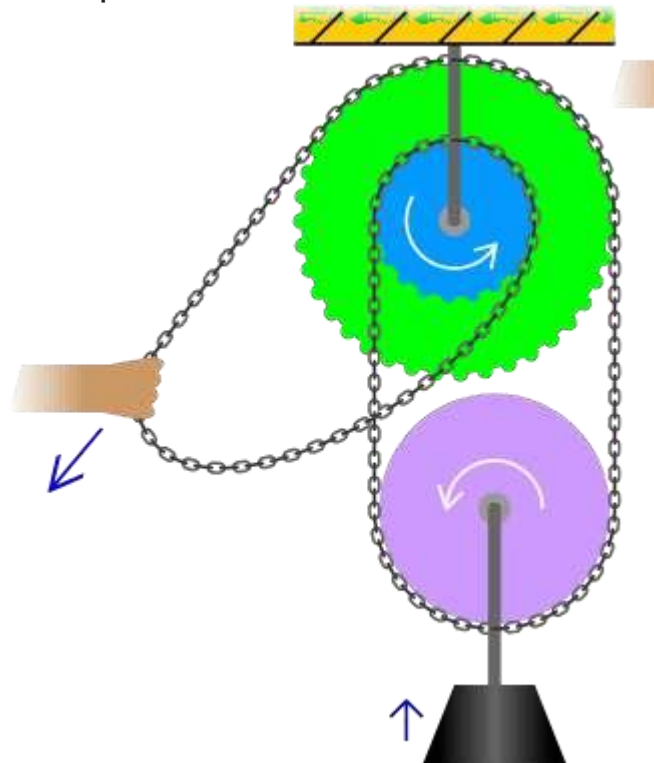

A basic example of a mechanical actuator is chain block hoisting weight in which mechanical motion of chain over the sprocket is utilized to lift a rated load.

### **Pneumatic Actuator:**

Pneumatic energy is most commonly used for actuators used for main engine controls. In this type, compressed air at high pressure is used which converts this energy into either linear or rotary motion.

A pneumatic actuator converts energy formed by vacuum or compressed air at high pressure into either linear or rotary motion. Pneumatic energy is desirable for main engine controls because it can quickly respond in starting and stopping as the power source does not need to be stored in reserve for operation. Moreover, pneumatic actuators are safer, cheaper, and often more reliable and powerful than other actuators.

Pneumatic actuators enable considerable forces to be produced from relatively small pressure changes. These forces are often used with valves to move diaphragms to affect the flow of liquid through the valve.

### **Hydraulic Actuator:**

Unlike air, liquid cannot be compressed and hence hydraulics generates higher energy than any other system. All systems involving high loads are operated by hydraulic actuators in which oil pressure is applied on mechanical actuator to give an output in terms of rotary or linear motion.

A hydraulic actuator consists of cylinder or fluid motor that uses hydraulic power to facilitate mechanical operation. The mechanical motion gives an output in terms of linear, rotatory or oscillatory motion. As liquids are nearly impossible to compress, a hydraulic actuator can exert a large force. The drawback of this approach is its limited acceleration.

The hydraulic cylinder consists of a hollow cylindrical tube along which a piston can slide. The term *single acting* is used when the fluid pressure is applied to just one side of the piston. The piston can move in only one direction, a spring being frequently used to give the piston a return stroke. The term *double acting* is used when pressure is applied on each side of the piston; any difference in pressure between the two sides of the piston moves the piston to one side or the other.

### **Electrical Actuator:**



It is one of the cleanest and readily available forms of actuating system as it does not involve oil; as there is no need to compress air, hence no extra machinery. Electrical energy is always available on ship. The electrical energy is used to actuate a mechanical system using magnetic field i.e. EMF. Basic examples are electrical motor operated valve and magnetic valve actuator or solenoid valve.

An electric actuator is powered by a motor that converts electrical energy into mechanical torque. The electrical energy is used to actuate equipment such as multi-turn valves. Additionally, a brake is typically installed above the motor to prevent the media from opening valve. If no brake is installed, the actuator will uncover the opened valve and rotate it back to its closed position. If this continues to happen, the motor and actuator will eventually become damaged.<sup>[6]</sup> It is one of the cleanest and most readily available forms of actuator because it does not directly involve oil or other fossil fuels.

### **Hybrid Actuators:**

These are a mixture of some of the above systems which control the mechanical part of the system. Common example is a thermo hydraulic Electronic actuator used in operating valves in hot water system, wherein hot water liquid is used along with electronic system acting as control for the valve

### **Examples of actuators**

- Comb drive
- Digital micromirror device
- Electric motor
- Electroactive polymer
- Hydraulic cylinder
- Piezoelectric actuator
- Pneumatic actuator
- Screw jack
- Servomechanism
- Solenoid
- Stepper motor
- Shape-memory alloy
- Hydraulic actuators

### **Performance metrics**

Performance metrics of actuators include speed, acceleration, and force (alternatively, angular speed, angular acceleration, and torque), as well

as energy efficiency and considerations such as mass, volume, operating conditions, and durability, among others.

➤ **Force**

When considering force in actuators for applications, two main metrics should be considered. These two are static and dynamic loads. Static load is the force capability of the actuator while not in motion. Conversely, the dynamic load of the actuator is the force capability while in motion.

➤ **Speed**

Speed should be considered primarily at a no-load pace, since the speed will invariably decrease as the load amount increases. The rate the speed will decrease will directly correlate with the amount of force and the initial speed.

➤ **Operating conditions**

Actuators are commonly rated using the standard [IP Code](#) rating system. Those that are rated for dangerous environments will have a higher IP rating than those for personal or common industrial use.

➤ **Durability**

This will be determined by each individual manufacturer, depending on usage and quality.

## **ACTUATING DEVICES**

**Actuating devices** in access control systems directly reduce or give access towards different areas of controlled territory or the object. Steered latches, locks, turnstiles of different variants, elevators, entrance security cabins, automatic gates and lots of others are used as actuating devices. Control of actuating devices is fulfilled by the controllers of access control system. The selection of actuating device depends upon the object's type, upon the equipment's service conditions, specifics of the mode and upon security requirements on the object. Depending upon these and some other factors the variant of actuating devices' access control system can differ a lot.

➤ **Electromechanical locks and latches**

**Electromechanical locks** and latches operate quite simply. In electromechanical catchers the electromagnet is used, which under tension drags the locking device enabling opening of the door. In powerful locks of vault type special electric drive is used for opening-closing of the locking

pins. If building object is planned to be equipped by the access control system electromechanical locks should be better used as actuating devices. In case of fitting put of the operating object electromechanical latches should be better chosen, which can be utilized alongside with already installed locking devices.

➤ **Electromagnetic locks**

**Electromagnetic lock** is a powerful magnet installed on the doorframe and a metal plate fixed on the door. The electromagnet is supplied by electric hold-on current; it attracts and holds the door with the plate.

Electromagnets used in electromagnet locks can have retentivity power up to one ton and more. While door-open signal injection electromagnet power is switched off and the door can be freely opened. Doors with electromagnetic locks should be by all means equipped by the door closers for resetting into initial position.

➤ **Turnstiles**

**Turnstile** is a revoluted system for access control to the secured territory.

Turnstiles thanks to their construction have high throughput efficiency; that is why they are installed in places of mass pass onto enclosed territory – checkpoints, railway/metro line stations and i.e. In ordinary state the turnstile blocks the passage, while open-passage signal injection the turnstile can freely rotate about its axis enabling the pass onto the territory of the object.

There are half- and full-length turnstiles. Half-length turnstiles can be got over, that is why they are used on the objects with low and moderate security requirements and are installed in direct closeness to the watchpost. For important objects full-length turnstiles should be better used, they thoroughly block the passage ability to the territory.

➤ **Entrance security cabins**

**Entrance security cabins** like turnstiles are intended for installation in places of mass pass to the secured territory, but entrance security cabins supply intensified security level having at the same time lower flow capacity. Entrance security cabin of a tambour type is the premises with two doors among which only one can remain open.

After entrance to the security cabin, the first door closes and only after controller's access admittance signal the second door opens. Entrance security cabin of the tambour type meets high security requirements but has minimal flow capacity – 8/12 persons per minute.

To increase throughput capacity entrance security cabins of rotary type are used; one rotary door is used in them, reminding turnstile by its construction. Rotary entrance security cabins can meet high security requirements, at the same time their flow capacity is two times higher than entrance security cabins of tambour type-18/22 persons per minute.

To increase efficiency of entrance security cabins variety of certain devices - input metal detectors for weapons disclosure and weighing systems, averting simultaneous passage of more than one person are used in their construction. Entrance security cabins are manufactured of armor-coated glass or of the metal.

#### ➤ **Elevators**

**Elevators** are also used as one of the variants of actuating devices in access control systems. Elevator is an entrance security cabin by its essence from which a person can get only to those floors where he has access authorization. Elevator's stop on another floors and door opening is forbidden by access control system.

#### ➤ **Automatic gates and turnstiles**

**Automatic gates and turnstiles** are used for limitation of free automobile transport movement. Automatic turnstiles of different constructions as well as automatic gates of various versions – swinging, sliding, upward acting gates and roller shutters are used for this purpose. On the ordinary objects gates or turnstiles are enough means for transport's encroachment restriction to the enclosed territory. On the objects with high security level anti-ram barriers for emergency automobile braking are used further to the gates and turnstiles.

#### ➤ **Other examples**

- Video surveillance systems
- Perimeter security systems
- Alarm systems
- Access control systems
  - Actuating devices
  - Controllers
  - Entryphones
  - Keys and readers

Real time interfacing: Introduction, Element of a Data Acquisition and control system, overview of the I/O process. Installation of the I/O card and software.

## Real time interface

- What is real time?
- Real-time is a quantitative notion of time. Real-time is measured using a physical (real) clock.
- In contrast to real time, logical time (also known as virtual time) deals with a qualitative notion of time and is expressed using event ordering relations such as before, after, sometimes, eventually, precedes, succeeds, etc.
- A system is called a real-time system, when we need quantitative expression of time (i.e. real-time) to describe the behavior of the system.

## Basic model of RTI

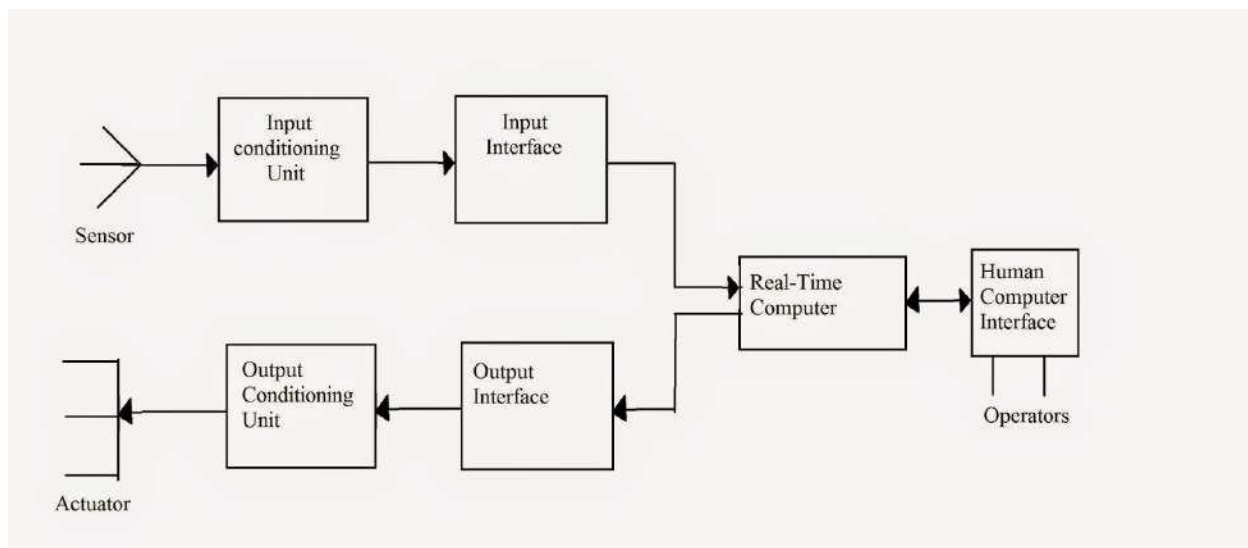

- **Sensor:** converts some physical characteristic of its environment into electrical signals. An example of a sensor is a photo-voltaic cell which converts light energy into electrical energy. A wide variety of

temperature and pressure sensors are also used. A temperature sensor typically operates based on the principle of a thermocouple.

- **Actuator:** Device that takes its inputs from the output interface of a computer and converts these electrical signals into some physical actions on its environment.

Physical actions :- motion, change of thermal, electrical, pneumatic, or physical characteristics of some objects.

Eg:- motor

Signal Conditioning Units:

Electrical signals produced by a computer can rarely be used to directly drive an actuator. The computer signals usually need conditioning before they can be used by the actuator. This is termed output conditioning. Input conditioning is required to be carried out on sensor signals before they can be accepted by the computer.

-Important types of conditioning carried out on raw signals generated by sensors and digital signals generated by computers

1. Voltage amplifier
  2. Voltage level shifting
  3. Frequency range shifting and filtering
  4. Signal mode conversion
- **Interface Unit:** Normally commands from the CPU are delivered to the actuator through an output interface. An output interface converts the stored voltage into analog form and then outputs this to the actuator circuitry. This of course would require the value generated to be written on a register

## Characteristics

- Time constraints
- New Correctness Criterion
- Embedded
- Safety-Criticality
- Concurrency
- Distributed and Feedback Structure
- Task criticality
- Custom hardware
- Reactive
- Stability
- Exception handling

### **Types of real time task**

- A real-time task can be classified into
  - ✓ Hard real-time task
  - ✓ Soft real-time task
  - ✓ Firm real-time task

#### **Hard Real-Time Tasks**

A hard real-time task is one that is constrained to produce its results within certain predefined time bounds. The system is considered to have failed whenever any of its hard real-time tasks does not produce its required results before the specified time bound.

#### **Firm Real-Time Tasks**

Every firm real-time task is associated with some predefined deadline before which it is required to produce its results. 1.7.3. Soft Real-Time Tasks

**Soft real-time tasks** also have time bounds associated with them. However, unlike hard and firm real-time tasks, the timing constraints on soft real-time tasks are not expressed as absolute values. Instead, the constraints are expressed either in terms of the average response times required.

## Applications

- Industrial Applications

Example 1: Chemical Plant Control

Chemical plant control systems are essentially a type of process control application. In an automated chemical plant, a real-time computer periodically monitors plant conditions.

Example 2: Automated Car Assembly Plant

Ex-3 Medical

Robot Used in Recovery of Displaced Radioactive Material

Ex-4 Peripheral equipments

Ex 5: Laser Printer

Ex-6. Internet and Multimedia Applications video conferencing

## Elements of data acquisition

- What is Data acquisition?

Data acquisition systems are used by most engineers and scientists for laboratory research, industrial control, test and measurement to input and output data to and from a computer.

### Elements

- Sensor
- Signal conditioning
- Analog input(A/D) board



- Computer
- Output interface

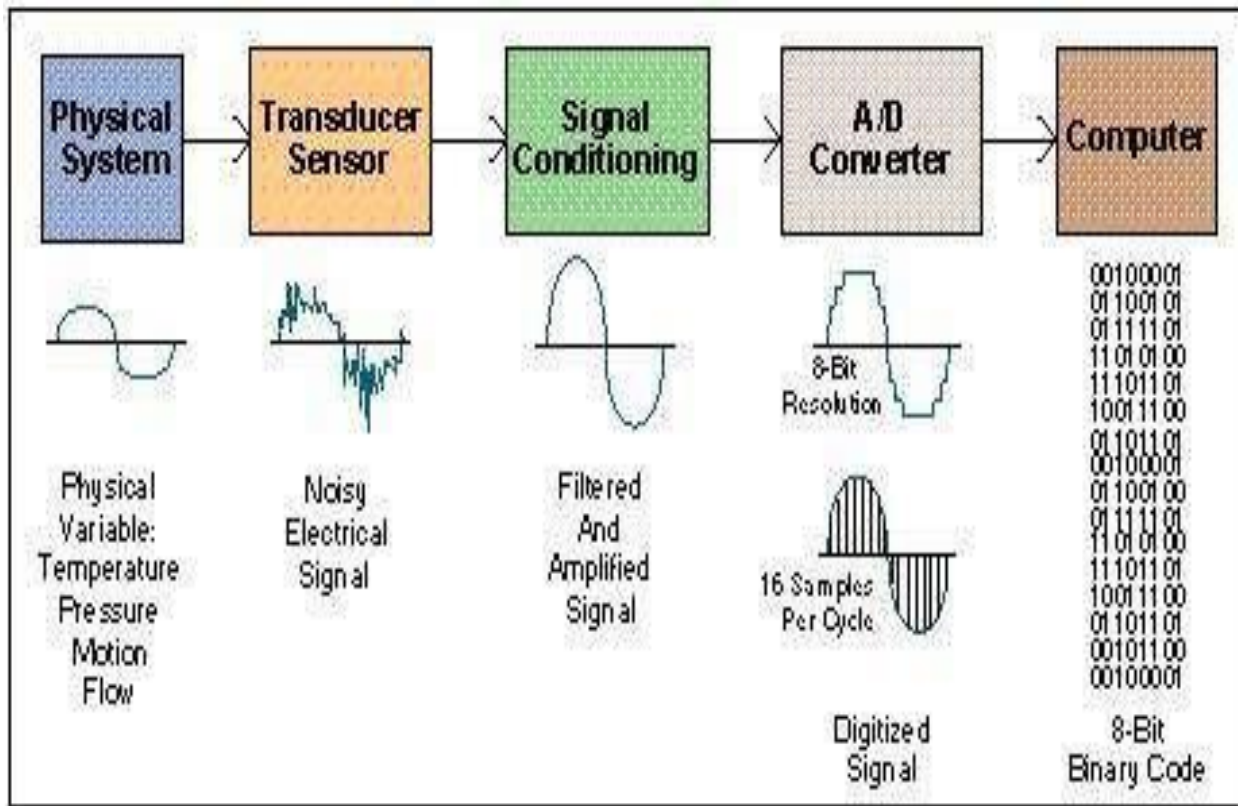

DAQ BLOCK DIAGRAM

Sensor

Measures physical variables such as temperature, strain, flow force and motion

Signal conditioning:-

To convert sensor outputs into signals readable by analog input board (A/D) in the PC

Analog Input (A/D) board:-

- Converts these signals into digital format usable by PC
- Computer:

- A computer with appropriate software to process, analyze and lock the data to the disk. Such software may also provide a graphical display of the data.
- Output Interface:
- Provides an appropriate process control response

## **Module-Iv**

Application of software in Mechatronics: Advance application in Mechantronics. Sensors for conditioning Monitoring, Mechatronic Control in Automated Manufacturing, Micro sensors in Mechatronics. Case studies and examples in Data Acquisition and control. Automated manufacturing etc.

### **Application of software in Mechatronics**

- ▶ Modelling, analysis, design, data acquisition, and control are important activities within the field of Mechatronics.
- ▶ Computer software tools and environments are available for effectively carrying out, both at the learning level and at the professional application level.
- ▶ MATLAB is an interactive computer environment with a high-level language and tools for scientific and technical computation, modelling and simulation, design, and control of dynamic systems.
- ▶ SIMULINK is a graphical environment for modelling, simulation, and analysis of dynamic systems, and is available as an extension to MATLAB.

- ▶ LabVIEW is graphical programming language and a program development environment for data acquisition, processing, display, and instrument control.
- ▶ Simulink provides a graphical environment for modeling, simulating, and analyzing linear and nonlinear dynamic systems. First a suitable block diagram model of the system is developed on the computer screen, and stored.
- ▶ The SIMULINK environment provides almost any block that is used in a typical block diagram. These include transfer functions, integrators, gains, summing junctions, inputs (i.e., source blocks), and outputs (i.e., graph blocks or scope blocks).
- ▶ Such a block may be selected and inserted into the workspace as many times as needed, by clicking and dragging using the mouse. These blocks may be connected as required, using directed lines.
- ▶ A block may be opened by clicking on it, and the parameter values and text may be inserted or modified as needed. Once the simulation block diagram is generated in this manner, it may be run and the response may be observed through an output block (graph block or scope block).
- ▶ There are two types of elements in SIMULINK: blocks and lines. Blocks are used to generate (or input), modify, combine, output, and display signals. Lines are used to transfer signals from one block to another.

### **Starting Simulink**

- ▶ First enter the MATLAB environment. You will see the MATLAB command prompt >>. To start SIMULINK, enter the command: simulink. Alternatively, you may click on the “Simulink” button at the top of the MATLAB command window.
- ▶ Basic Elements:-
- ▶ There are two types of elements in SIMULINK: blocks and lines. Blocks are used to generate (or input), modify, combine, output, and display signals. Lines are used to transfer signals from one block to another.
- ▶ Blocks:-
- ▶ The subfolders below the SIMULINK folder show the general classes of blocks available for use. They are
  - ▶ • Continuous: Linear, continuous-time system elements (integrators, transfer functions, state-space models, etc.)
- ▶ A signal can be either a scalar signal (single signal) or a vector signal (several signals in parallel). The lines used to transmit scalar signals and vector signals are identical; whether it is a scalar or vector is determined by the blocks connected by the line.

## a) SIMULINK model of a robotic sewing machine

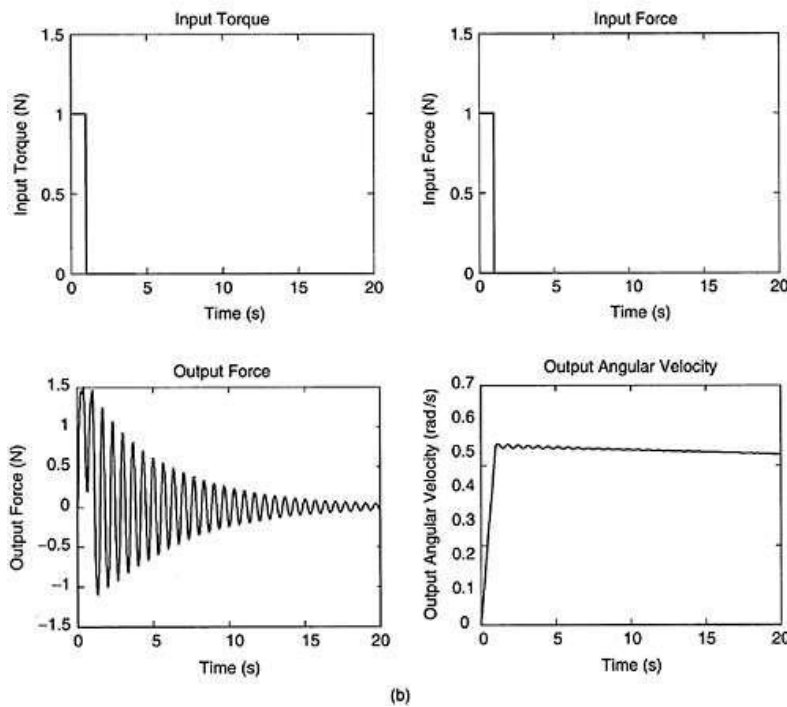
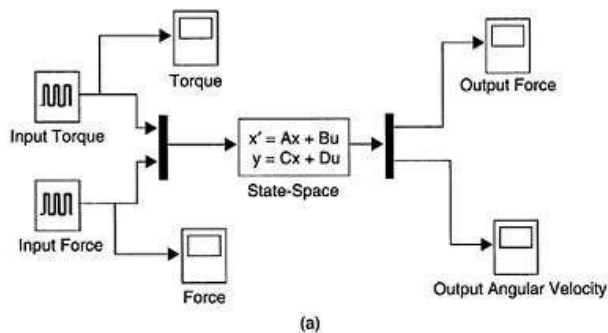

(b) Simulation results.

**MATLAB:**

- ❖ MATLAB interactive computer environment is very useful in computational activities in Mechatronics.
- ❖ Computations involving scalars, vectors, and matrices can be carried out and the results can be graphically displayed and printed.
- ❖ MATLAB toolboxes are available for performing specific tasks in a particular area of study such as control systems, fuzzy logic, neural network, data acquisition, image processing, signal processing,

system identification, optimization, model predictive control, robust control, and statistics.

- ❖ Mathematical computations can be done by using the MATLAB command window. Simply type in the computations against the MATLAB prompt ">>" as illustrated next.

An example of a simple computation using MATLAB is given below.

```
>> x=2; y=-3;
>> z=x^2-x*y+4
z=-14
```

### MATLAB Arithmetic Operations

Symbol	Operation
+	Addition
-	Subtraction
*	Multiplication
/	Division
^	Power

### Useful Mathematical Functions in MATLAB

Function	Description
abs()	Absolute value/magnitude
acos()	Arc-cosine (inverse cosine)
acosh()	Arc-hyperbolic-cosine
asin()	Arc-sine
atan()	Arc-tan
cos()	Cosine
cosh()	Hyperbolic cosine
exp()	Exponential function
imag()	Imaginary part of a complex number
log()	Natural logarithm
log10()	Log to base 10 (common log)
real()	Real part of a complex number
sign()	Signum function
sin()	Sine
sqrt()	Positive square root
tan()	Tan function

### Some Relational Operations

Operator	Description
<	Less than
<=	Less than or equal to
>	Greater than
>=	Greater than or equal to
= =	Equal to
~ =	Not equal to

#### ❖ Basic Logical Operations

Operator	Description
&	AND
	OR
~	NOT

### LABVIEW

- LabVIEW or Laboratory Virtual Engineering Workbench is a product of National Instruments. It is a software development environment for data acquisition, instrument control, image acquisition, motion control, and presentation.
- LabVIEW is a compiled graphical environment, which allows the user to create programs graphically through wired icons similar to creating a flowchart.

#### Working with LabVIEW:-

- As a software centered system, LabVIEW resides in a desktop computer, laptop or PXI as an application where it acts as a set of virtual instruments (VIs), providing the functionality of traditional hardware instruments such as oscilloscopes.
- Comparing to physical instruments with fixed functions, LabVIEW VIs are flexible and can easily be reconfigured to different applications.
- It is able to interface with various hardware devices such as GPIB, data acquisition modules, distributed I/O, image acquisition, and motion control, making it a modular solution.

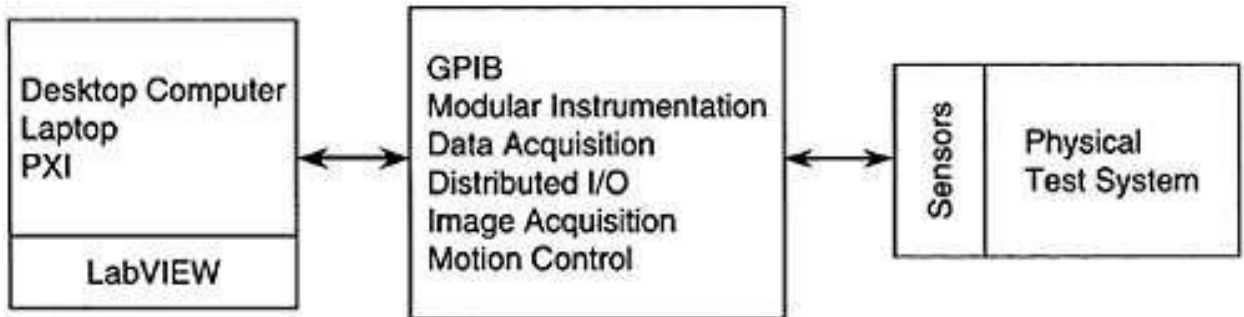

## ADVANCED APPLICATION OF MECHATRONICS

Application areas of mechatronics are numerous, and involve that concern mixed systems and particularly electromechanical systems.

These application may involve:

1. Modification and improvements to conventional designs by using a mechatronics approach.
2. Development and implementation of original and innovative mechatronics system.

In either category, the application will employ sensing, actuation, control, signal conditioning, component interconnection and interfacing, and communication, generally using tools of mechanical, electrical and electronic, computer and control engineering.

- Some important areas of application are indicated below.
  - Transportation
  - Manufacturing and production engineering
  - Medical and healthcare
  - Modern office environment
  - Household application
  - Computer industry
  - Civil engineering
  - Space engineering
  - Military purpose

Transportation:

There are two field used in the mechatronics system

1. Ground transportation
2. Air transportation

1. Ground transportation:

In ground transportation in particular automobiles, trains, and automated transit systems use mechatronics devices. They include

1. Airbag deployment systems
2. Antilock braking systems(ABS)
3. Cruise control system
4. Active suspension system
5. Navigation
6. Control in intelligent vehicular highway systems(IVHS)



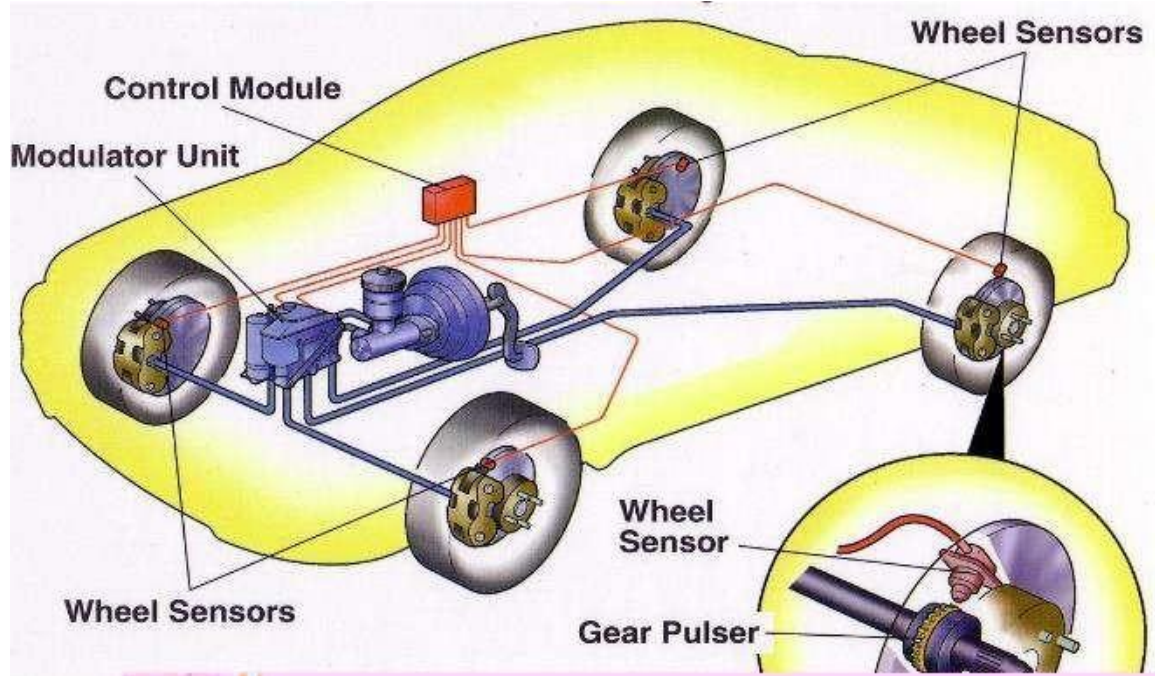

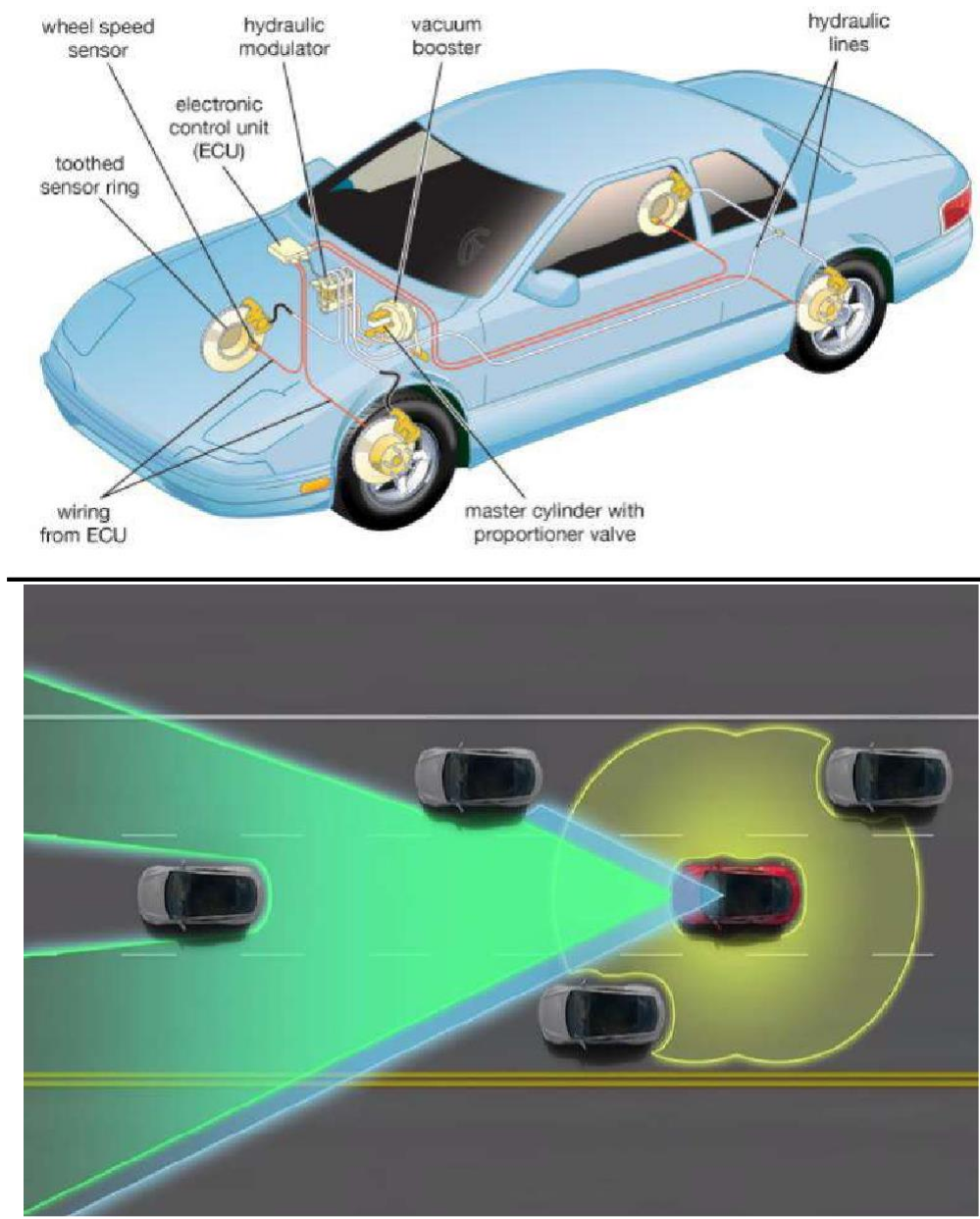

## 2. Air transportation:

- Modern aircraft designs with advanced materials, structures, electronics, and control benefit from the concurrent and integrated approach of mechatronics to develop improved
  - Designs of flight simulators
  - Navigation systems
  - Flight control system

- Landing gear mechanisms
- Travelers comfort aids





### Manufacturing and production engineering:

- Manufacturing And Production Engineering is another broad field that uses mechatronics technologies and systems.
  - Factory robots (for welding, spray painting, assembly, inspection, etc.)
  - Automated guided vehicles(AGVs)
  - Modern computer-numerical control (CNC) machine tools
  - Machining centre
  - Rapid(and virtual) prototyping systems
  - Micromachining systems



Medical and healthcare:

- General patient care are being developed and used.
  - Patient transit devices
- In medical and healthcare application, robotic technologies for example
  - Surgery
  - Rehabilitation(regain or improve neurocognitive function that has been lost or diminished)
  - Drug dispensing(intermediary drug)
  - Various diagnostic probes
  - Scanners
  - Beds

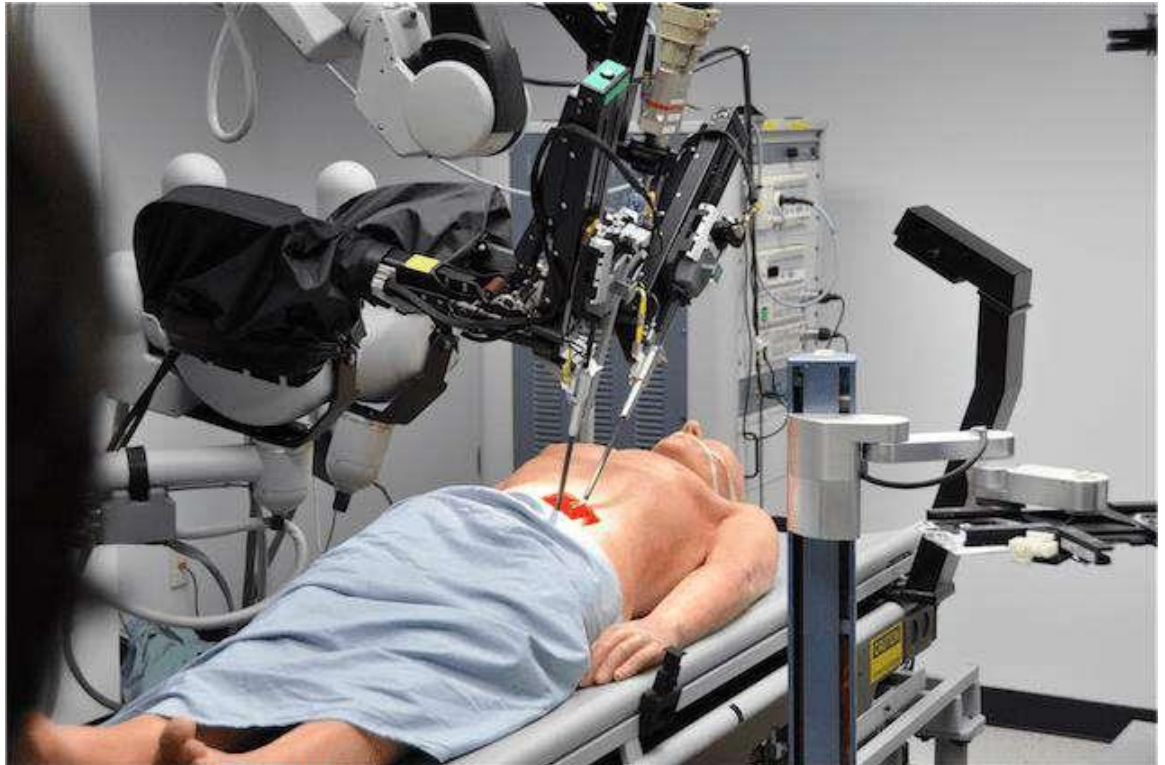

Exercise machines

Modern office environment:

1. Automated filing systems
2. Multi-functional copying machines (perform copying, scanning, printing, fax, etc)
3. Food dispensers
4. Multimedia presentation
5. Meeting rooms
6. Climate control system, incorporate mechatronics technology



#### Household application:

- In household application,
  - Home security systems and robots
  - Vacuum cleaners and robots
  - Washers
  - dryers
  - Dishwashers
  - Garage door openers
  - Entertainment centers



### Computer industry:

- In this computer industry
  - Hard disk drives(HDD)
  - Disk retrieval ejection devices
  - Cooling fan



### Civil engineering:

- In civil engineering application
  - Cranes
  - Excavators
  - Earth removal.
  - Mixing and so on, will improve their performance by adopting a mechatronic design approach

### Space application:

- In space application
  - Mobile robots such as NANA's mars exploration rover
  - Space station robots
  - Space vehicles are fundamentally mechatronics systems

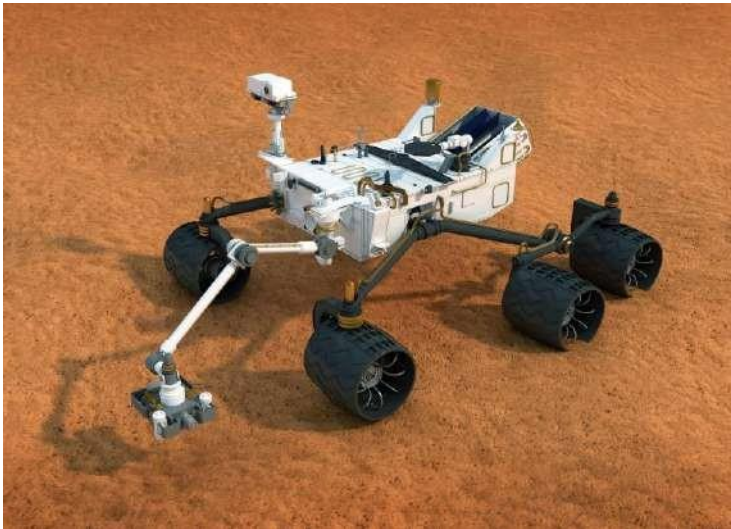

Military Applications:

- In military application
  - Bomb detection robot
  - Surveillance vehicles
  - Drones

